

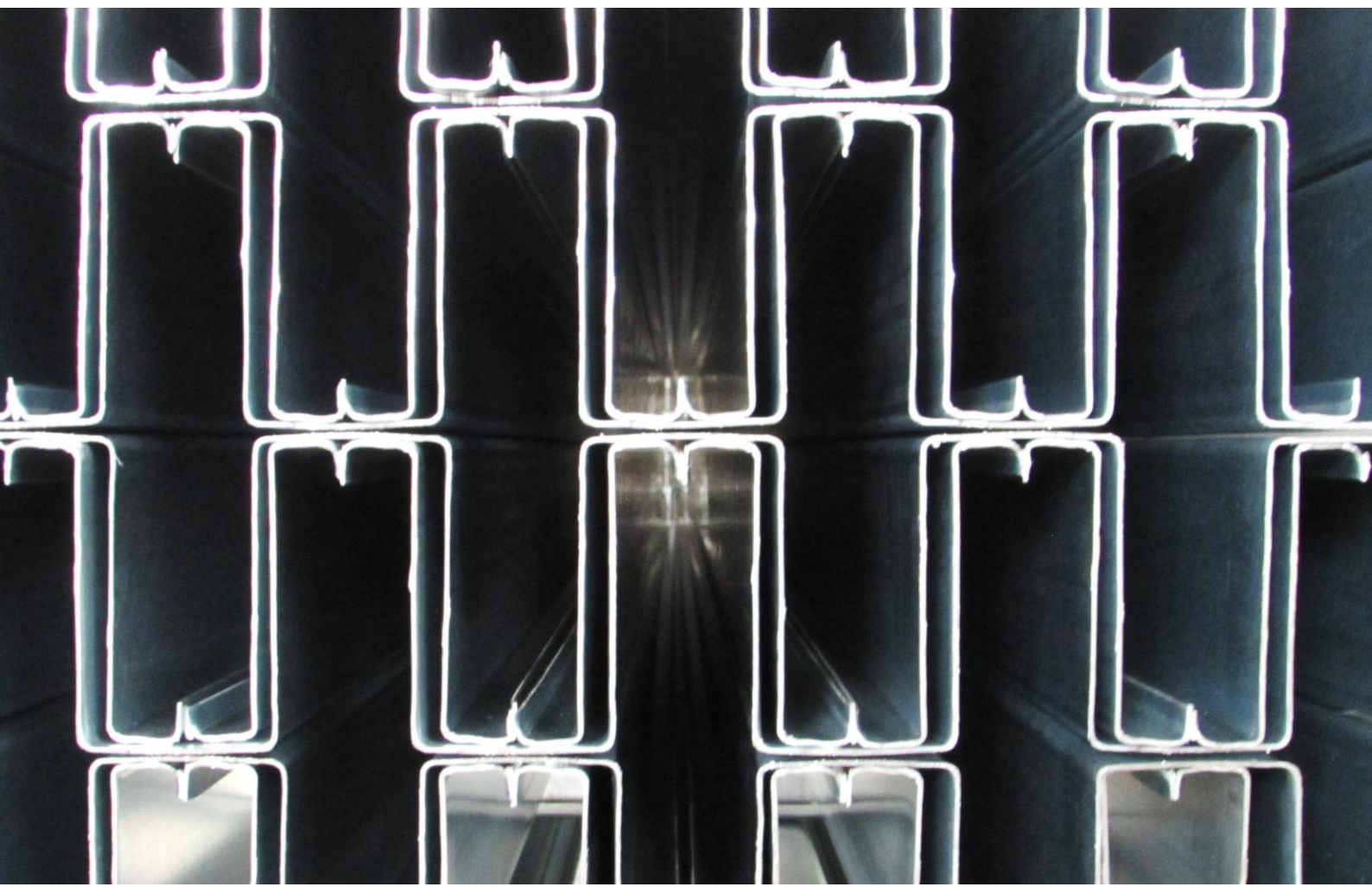

BARRALFERROS



BARRAFERROS, LDA.	3
SETORES DE ATIVIDADE · SECTORES OF ACTIVITY	4
CERTIFICAÇÃO · CERTIFICATION	6
PRÉMIOS · AWARDS	7
PRODUTOS · PRODUCTS	8
INDÚSTRIA · INDUSTRY	8
OMEGA OB	9
OMEGA	10
OMEGA R	10
SUPORTE · SUPPORT	10
Z	11
C	12
G40	13
TUBULAR	14
HABITAÇÃO · RESIDENCE	15
VIGA TRELIÇADA · TRUSS BEAM	16
COBERTURA COM VÃO APROVEITADO · ATTIC ROOF	17
RBF	18
RBF & OB35/40	18
RBF & UB120	18
CP	19
UB40 & UB60	19
RIPAS · PURLINS	20
C & U (ESTRUTURA EM AÇO LEVE · LIGHT STEEL FRAMING)	21
ENERGIA · ENERGY	22
PERFIS PARA PAINÉIS FOTOVOLTAICOS SECTIONS FOR PHOTOVOLTAIC PANELS	23
AGRICULTURA · AGRICULTURE	24
PERFIS PARA ESTUFAS · SECTIONS FOR GREENHOUSES	25
ESTACA · STAKE	26
CABECEIRA · HEADSTAKE	26
PORTÕES · GATES	27
PERFIL PORTÃO DE CORRER · SECTION FOR SLIDING GATE	28
PORTÕES DE FOLE · FOLDING GATES	28
CORTE E QUINAGEM · CUTTING AND PRESS BRAKING	29
PROPRIEDADES DOS MATERIAIS · MATERIAL PROPERTIES	30

EMPRESA ESPECIALIZADA NO DESIGN, DESENVOLVIMENTO E FABRICO DE PERFIS EM AÇO ENFORMADO A FRIO



Os perfis em aço enformados a frio apresentam muitas vantagens quando comparados com outras soluções, nomeadamente a boa relação entre a resistência e o peso, fabrico industrial rápido e limpo, facilidade de elevação e montagem em obra.

A Barraferros com o design, desenvolvimento e fabrico de perfis em aço enformado a frio, por perfilagem e quinagem, para os setores da construção, reabilitação, energia e agricultura, contribui para projetos mais económicos, sustentáveis e inteligentes.



perfis
em aço
steel
sections



mm de
espessura
mm of
thickness



aço estrutural
EN 10346
structural steel
EN 10346



aço inoxidável
EN 10088
stainless steel
EN 10088

COMPANY SPECIALIZED IN THE DESIGN, DEVELOPMENT AND PRODUCTION OF COLD FORMED STEEL SECTIONS



Cold-formed steel sections have many advantages when compared to other solutions, namely the good ratio between strength and weight, fast and clean industrial production, ease of lifting and assembly on site.

Barraferros, with the design, development and manufacture of cold-formed steel sections, by profiling and press bending, for the construction, retrofitting, energy, and agriculture sectors, contributes to more economical, sustainable, and intelligent projects.



INDÚSTRIA

perfis para estrutura de suporte de cobertura e fachada

INDUSTRY

sections for roof and facade cladding structure



HABITAÇÃO

perfis para pilares, vigas, paredes, pisos e cobertura

RESIDENCE

sections for columns, beams, walls, floors and roof

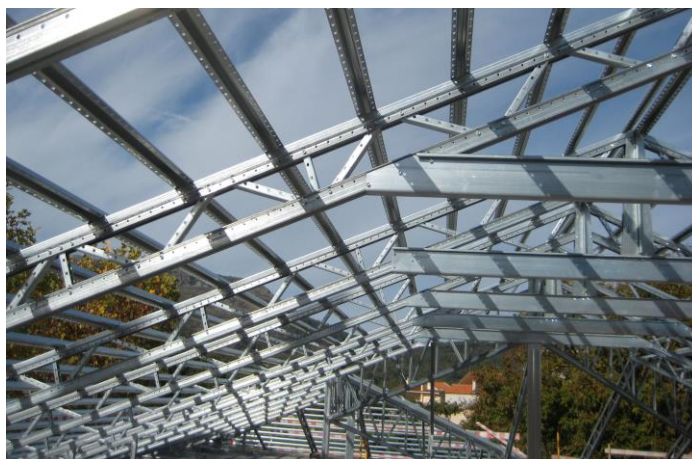

ENERGIA

perfis para estrutura de suporte de painéis fotovoltaicos

ENERGY

sections for photovoltaic panels support structure





AGRICULTURA
perfis para culturas
agrícolas e estufas

AGRICULTURE
sections for
agriculture culture
and greenhouses



PORTÕES
portão de fole em
chapa de aço

GATES
steel sheet folding
gate



**CORTE E
QUINAGEM**
perfis
personalizados até
12 m de
comprimento

**CUTTING AND
PRESS BRAKING**
custom-made
sections until 12 m
of length



CERTIFICAÇÃO · CERTIFICATION

	Certificado de Conformidade do Controlo de Produção em Fábrica Certificate of Conformity of Factory Production Control
Produto Product	Aço Galvanizado Galvanized Steel
Norma Standard	EN 1090-1:2009 + A1:2011
Método de Declaração Declaration Method	2, 3a
Classe de Execução Execution Class	EXC2 (EN 1090-4)
Material de Base Base Material	S220GD, S280GD, S320GD, S350GD
	Sistema de Gestão da Qualidade Organizational Quality Management System
Norma Standard	ISO 9001:2015
	Sistema de Gestão da Segurança e Saúde no Trabalho Occupational Health and Safety Management System
Norma Standard	ISO 45001:2018



PRÉMIOS · AWARDS

O estatuto PME Líder é um selo de reputação criado pelo IAPMEI para distinguir o mérito das Pequenas e Médias Empresas Portuguesas com desempenho superior, com base nas melhores notações de rating e indicadores económico-financeiros.

The PME Líder status is a seal of reputation created by IAPMEI to distinguish the merit of Small and Medium Sized Portuguese Companies with superior performance, based on the best ratings and economic-financial indicators.

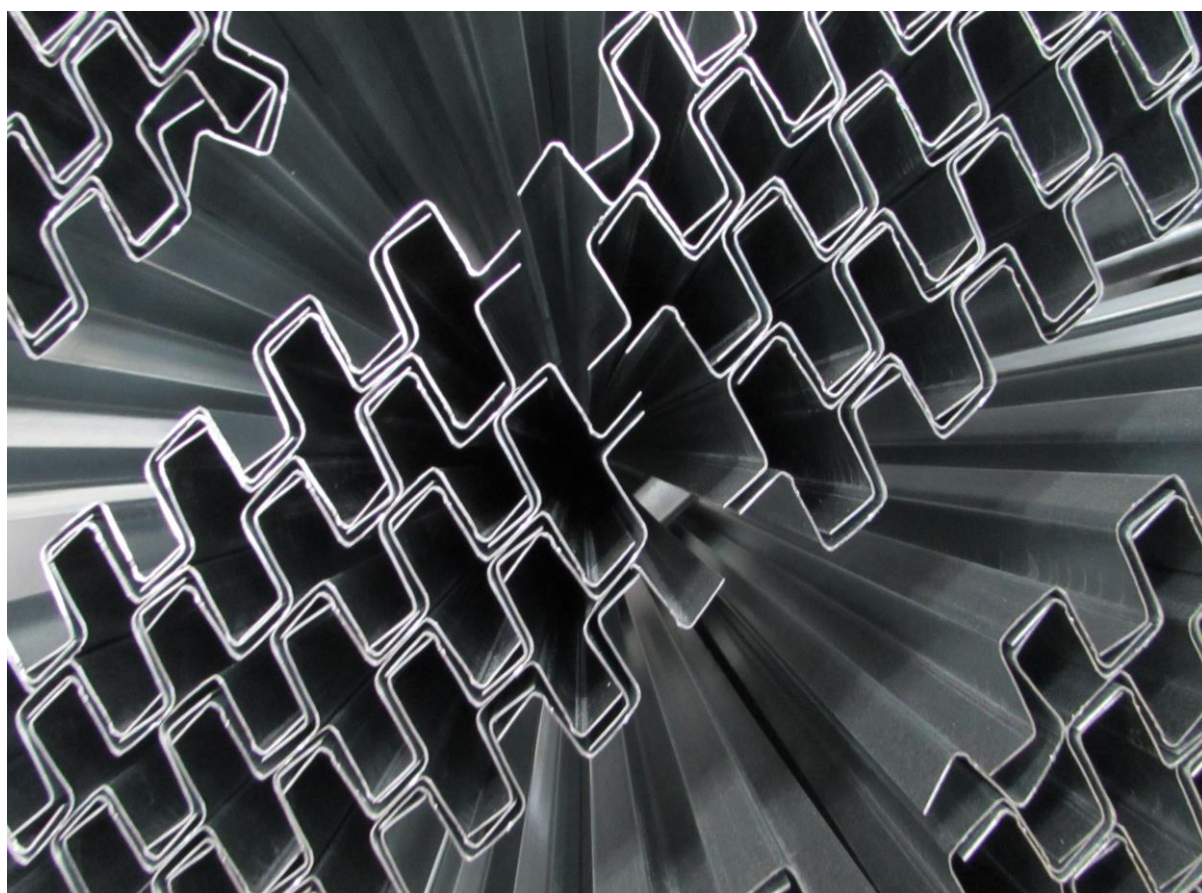



INDÚSTRIA
INDUSTRY

APLICAÇÃO

Estrutura para revestimento de cobertura e fachada (madres)
 Estrutura para piso
 Estrutura para painéis fotovoltaicos

APPLICATION

Structure for roof and facade cladding (purlins and side rails)
 Structure for floor
 Structure for photovoltaic panels

ESPECIFICIDADES

A configuração das secções permite a sobreposição vertical com as seguintes vantagens:

- Aumento da resistência na zona de sobreposição
- Redução do volume do lote de perfis no transporte
- Facilidade de montagem e ligação dos perfis

SPECIFICITIES

The configuration of the sections allows vertical overlap with the following advantages:

- Increase of the resistance in the overlap area
- Reduction of the profile set volume for transport
- Easy installation and connection of profiles on site

Esquema de sobreposição sugerido:

- Vãos internos – comprimento de sobreposição nos apoios igual a 20% do vão, sendo 10% para cada lado do apoio
- Vãos de extremidade – comprimento de sobreposição nos apoios igual a 25% do vão, sendo 10% no vão extremidade e 15% no vão interno adjacente

Suggested overlap scheme:

- Internal spans – overlap length at the supports equal to 20% of the span, 10% for each side of the support
- End spans – overlap length at the supports equal to 25% of the span, being 10% at the end span and 15% at the adjacent internal span

Furações:

- Furos ovais nas abas e almas
- De acordo com os requisitos de projeto

Holes:

- Oval holes in the lower flanges and webs
- According to design specifications

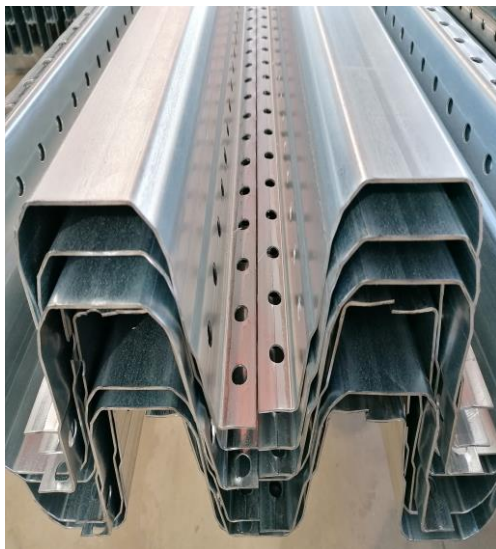
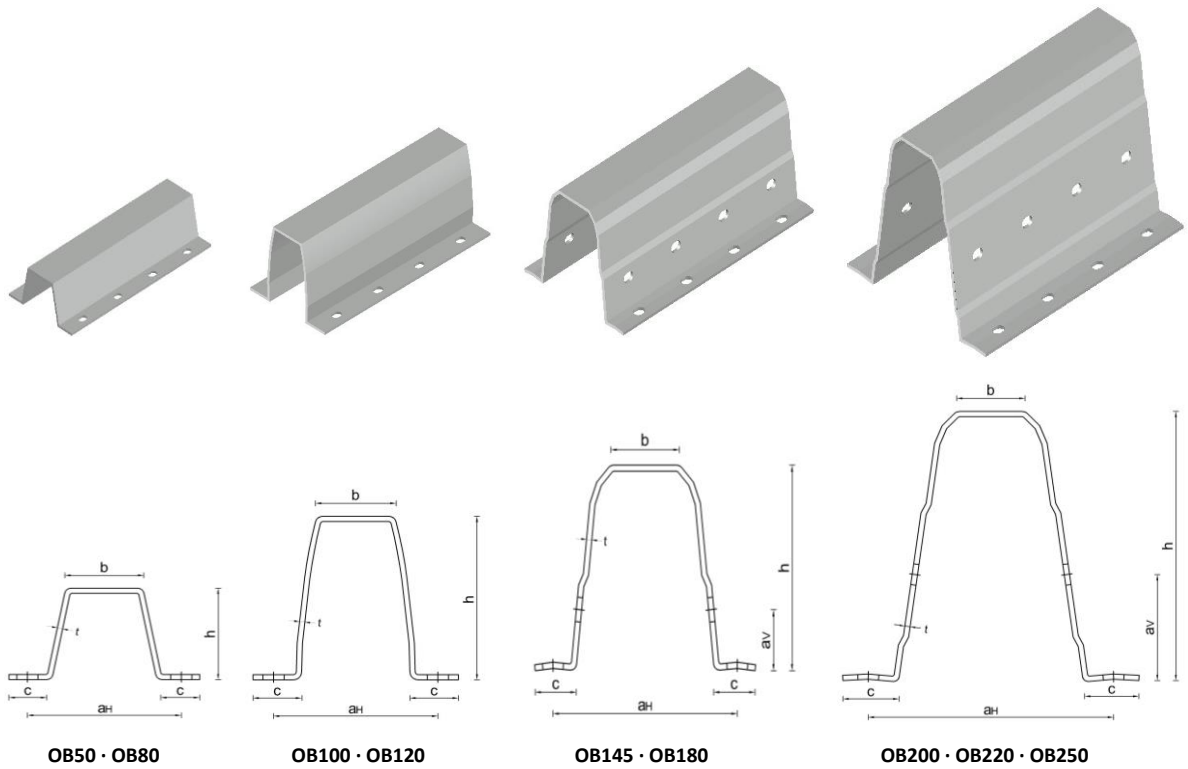

Seção Section	h (mm)	b (mm)	c (mm)	t _{nom} (mm)	∅ (mm)	a _H (mm)	a _V (mm)	P (kg/m)		
OB50x1.2	50	42	22	1.2	9.0x13.0 //50	82	--	1.70		
OB50x1.5				1.5				2.12		
OB80x1.5	1.5		3.00							
OB100x1.5	1.5		3.52							
OB100x2.0	100		30	2.0		4.69				
OB120x1.5	1.5			3.96						
OB120x2.0	120		2.0	5.28						
OB145x1.5	143		56	32		1.5		12.5x14.5 //50	150	37
OB145x2.0		2.0			6.48					
OB145x2.5		2.5			8.10					
OB180x1.5		1.5			5.94					
OB180x2.0	183	38		2.0	7.92					
OB180x2.5	2.5			9.90						
OB200x1.5	195	44		44	1.5	200	80		80	6.30
OB200x2.0					2.0					8.40
OB200x2.5			2.5		10.50					
OB220x1.5			1.5		7.08					
OB220x2.0	220		48	2.0	9.44					
OB220x2.5	2.5			11.80						
OB250x1.5	250		48	48	1.5		200	80	80	7.86
OB250x2.0					2.0					10.48
OB250x2.5		2.5			13.10					

OMEGA

APLICAÇÃO

Estrutura para revestimento de cobertura e fachada (madres)

Comprimento e furação de acordo com os requisitos

APPLICATION

Structure for roof and facade cladding (purlins and side rails)
Length and holes according to specifications

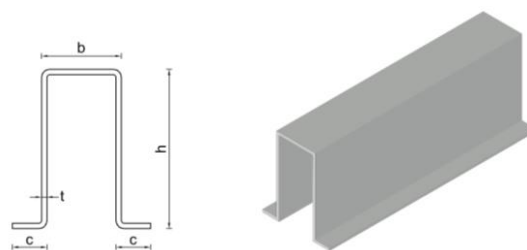

OMEGA R

APLICAÇÃO

Madres para cobertura e fachada de pavilhões industriais

Comprimento e furação de acordo com os requisitos

APPLICATION

Purlins and side rails for industrial buildings
Length and holes according to specifications

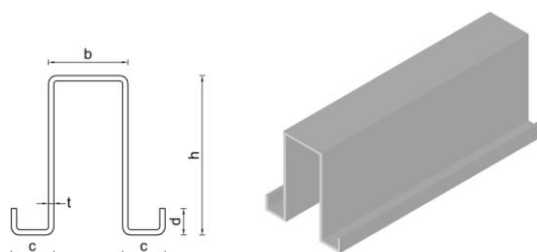

Seção Section	h (mm)	b (mm)	c (mm)	t _{nom} (mm)	P (kg/m)
O40/40/15x1.5	40	40	15	1.5	1.66
O50/40/16x1.5	50		16	1.5	1.92
O50/40/18x2.0			18	2.0	2.56
O100/65/20x1.5		65	20	1.5	3.52
O100/65/22x2.0	100		22	2.0	4.69
O100/65/24x2.5			24	2.5	5.86
O110/65/19x1.5		65	19	1.5	3.72
O110/65/21x2.0	110		21	2.0	4.96
O110/65/23x2.5			23	2.5	6.20
O120/65/19x1.5		65	19	1.5	3.96
O120/65/21x2.0	120		21	2.0	5.28
O120/65/23x2.5			23	2.5	6.60
O140/65/19x1.5		65	19	1.5	4.44
O140/65/21x2.0	140		21	2.0	5.92
O140/65/23x2.5			23	2.5	7.40
O160/65/16x1.5		65	16	1.5	4.86
O160/65/18x2.0	160		18	2.0	6.48
O160/65/20x2.5			20	2.5	8.10

Seção Section	h (mm)	b (mm)	c (mm)	d (mm)	t _{nom} (mm)	P (kg/m)
OR100/60/16/7x1.5	98	60	16	7	1.5	3.32
OR100/60/16/9x2.0				9	2.0	4.43
OR100/65/20/12x1.5	100	65	20	12	1.5	3.72
OR100/65/20/15x2.0				15	2.0	4.96
OR100/65/20/18x2.5				18	2.5	6.20
OR120/65/20/9x1.5	120	65	20	9	1.5	4.14
OR120/65/20/12x2.0				12	2.0	5.52
OR120/65/20/15x2.5				15	2.5	6.90
OR130/60/16/7x1.5	125	60	16	7	1.5	4.14
OR130/60/16/9x2.0				9	2.0	5.52
OR130/65/20/10x2.0	135	65	20	10	2.0	5.92
OR130/65/20/13x2.5				13	2.5	7.40
OR150/65/20/9x1.5	150	65	20	9	1.5	4.86
OR150/65/20/12x2.0				12	2.0	6.48
OR150/65/20/15x2.5				15	2.5	8.10
OR160/65/20/9x1.5	160	65	20	9	1.5	5.10
OR160/65/20/12x2.0				12	2.0	6.80
OR160/65/20/15x2.5				15	2.5	8.50

Outras dimensões sob consulta - Other dimensions on demand

Omega R b = 60 mm econômica - economic

SUPORTE · SUPPORT

APLICAÇÃO

Ligação para perfil OMEGA e OMEGA R

APPLICATION

Connection for section OMEGA and OMEGA R

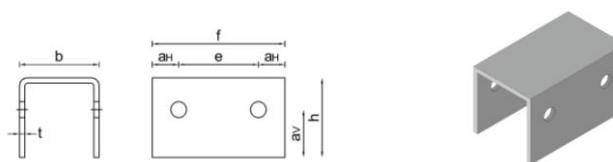

Seção Section	h (mm)	b (mm)	∅ (mm)	aH (mm)	e (mm)	f (mm)	aV (mm)	t _{nom} (mm)	P (kg/m)
SUP 2.0	70	60	14	28	70	125	40	2.0	3.07
SUP 2.5								2.5	3.84

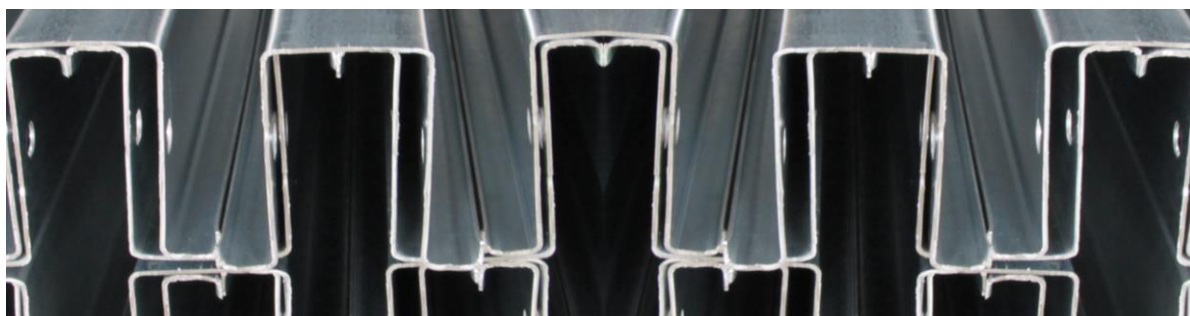

APLICAÇÃO

Estrutura para revestimento de cobertura e fachada (madres)

Comprimento e furação de acordo com os requisitos

APPLICATION

Structure for roof and facade cladding (purlins and side rails)

Length and holes according to specifications

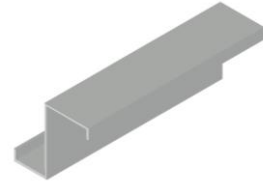
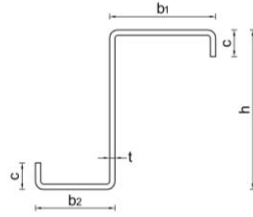

Seção Section	h (mm)	b ₁ (mm)	b ₂ (mm)	c (mm)	t _{nom} (mm)	P (kg/m)	
Z160/50-50/15x1.5	160	50	50	15	1.5	3.32	
Z160/50-50/17x2.0				17	2.0	4.43	
Z160/60-60/21x1.5		60	60	21	1.5	3.72	
Z160/60-60/23x2.0				23	2.0	4.96	
Z160/60-60/25x2.5				25	2.5	6.20	
Z160/70-60/16x1.5		70	60	16	1.5	3.72	
Z160/70-60/18x2.0				18	2.0	4.96	
Z160/70-60/20x2.5				20	2.5	6.20	
Z160/70-70/11x1.5			70	70	11	1.5	3.72
Z160/70-70/13x2.0					13	2.0	4.96
Z160/70-70/15x2.5					15	2.5	6.20
Z170/60-60/16x1.5		170	60	16	1.5	3.72	
Z170/60-60/18x2.0	18			2.0	4.96		
Z170/60-60/20x2.5	20			2.5	6.20		
Z180/60-60/21x1.5	180		60	21	1.5	3.96	
Z180/60-60/23x2.0				23	2.0	5.28	
Z180/60-60/25x2.5				25	2.5	6.60	
Z180/70-60/16x1.5		70	60	16	1.5	3.96	
Z180/70-60/18x2.0				18	2.0	5.28	
Z180/70-60/20x2.5				20	2.5	6.60	
Z180/70-70/19x1.5	70	70	19	1.5	4.14		
Z180/70-70/21x2.0			21	2.0	5.52		
Z180/70-70/23x2.5			23	2.5	6.90		
Z200/60-60/19x1.5		200	60	19	1.5	4.14	
Z200/60-60/21x2.0				21	2.0	5.52	
Z200/60-60/23x2.5				23	2.5	6.90	
Z200/70-60/14x1.5	70		60	14	1.5	4.14	
Z200/70-60/16x2.0				16	2.0	5.52	
Z200/70-60/18x2.5				18	2.5	6.90	
Z200/70-70/21x1.5			70	70	21	1.5	4.44
Z200/70-70/23x2.0					23	2.0	5.92
Z200/70-70/25x2.5					25	2.5	7.40
Z200/80-70/16x1.5	80		70	16	1.5	4.44	
Z200/80-70/18x2.0				18	2.0	5.92	
Z200/80-70/20x2.5				20	2.5	7.40	
Z220/60-60/21x1.5		220	60	21	1.5	4.44	
Z220/60-60/23x2.0				23	2.0	5.92	
Z220/60-60/25x2.5				25	2.5	7.40	
Z220/70-60/16x1.5	70		60	16	1.5	4.44	
Z220/70-60/18x2.0				18	2.0	5.92	
Z220/70-60/20x2.5				20	2.5	7.40	
Z225/80-70/25x2.5			225	80	25	2.5	8.10
Z225/80-70/27x3.0					27	3.0	9.72

Seção Section	h (mm)	b ₁ (mm)	b ₂ (mm)	c (mm)	t _{nom} (mm)	P (kg/m)			
Z240/60-60/13x2.0	240	60	60	13	2.0	5.92			
Z240/60-60/15x2.5				15	2.5	7.40			
Z240/70-60/24x1.5		70	60	24	1.5	4.86			
Z240/70-60/26x2.0				26	2.0	6.48			
Z240/70-60/28x2.5				28	2.5	8.10			
Z240/70-70/19x1.5		70	70	19	1.5	4.86			
Z240/70-70/21x2.0				21	2.0	6.48			
Z240/70-70/23x2.5				23	2.5	8.10			
Z240/80-70/14x1.5			80	70	14	1.5	4.86		
Z240/80-70/16x2.0					16	2.0	6.48		
Z240/80-70/18x2.5					18	2.5	8.10		
Z250/60-60/24x1.5		250	60	24	1.5	4.86			
Z250/60-60/26x2.0	26			2.0	6.48				
Z250/60-60/28x2.5	28			2.5	8.10				
Z250/70-60/19x1.5	70		60	19	1.5	4.86			
Z250/70-60/21x2.0				21	2.0	6.48			
Z250/70-60/23x2.5				23	2.5	8.10			
Z250/70-70/14x1.5			70	70	14	1.5	4.86		
Z250/70-70/16x2.0					16	2.0	6.48		
Z250/70-70/18x2.5					18	2.5	8.10		
Z250/80-70/19x1.5	80		70	19	1.5	5.10			
Z250/80-70/21x2.0				21	2.0	6.80			
Z250/80-70/23x2.5				23	2.5	8.50			
Z260/60-60/19x1.5		260	60	19	1.5	4.86			
Z260/60-60/21x2.0				21	2.0	6.48			
Z260/60-60/23x2.5				23	2.5	8.10			
Z260/70-60/14x1.5	70		60	14	1.5	4.86			
Z260/70-60/16x2.0				16	2.0	6.48			
Z260/70-60/18x2.5				18	2.5	8.10			
Z300/70-60/26x1.5			300	60	26	1.5	5.64		
Z300/70-60/28x2.0					28	2.0	7.52		
Z300/70-60/28x2.5					28	2.5	9.30		
Z300/70-60/32x3.0	70			60	32	3.0	11.28		
Z300/70-70/21x1.5					70	70	21	1.5	5.64
Z300/70-70/23x2.0							23	2.0	7.52
Z300/70-70/23x2.5	23	2.5		9.30					
Z300/70-70/27x3.0	80	70		27		3.0	11.28		
Z300/80-70/16x1.5				80		70	16	1.5	5.64
Z300/80-70/18x2.0							18	2.0	7.52
Z300/80-70/18x2.5	18	2.5			9.30				
Z300/80-70/22x3.0	80	70			22	3.0	11.28		
Z300/80-80/25x3.0			80		70	25	3.0	11.64	
Z375/96-85/30x4.0						375	96	85	30

Outras dimensões sob consulta · Other dimensions on demand



APLICAÇÃO

Estrutura para revestimento de cobertura e fachada (madres)

Comprimento e furação de acordo com os requisitos

APPLICATION

Structure for roof and facade cladding (purlins and side rails)

Length and holes according to specifications

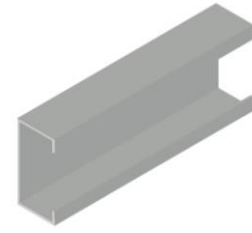
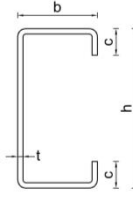

Seção Section	h (mm)	b (mm)	c (mm)	t _{nom} (mm)	P (kg/m)	
C100/50/13x1.5	100	50	13	1.5	2.57	
C100/50/15x2.0			15	2.0	3.42	
C100/55/15x2.0		55	15	2.0	3.58	
C100/55/17x2.5			17	2.5	4.48	
C120/55/16x1.5	120	55	16	1.5	3.00	
C120/55/18x2.0			18	2.0	4.00	
C120/55/20x2.5		60	20	2.5	5.00	
C120/60/11x1.5			11	1.5	3.00	
C120/60/13x2.0		13	2.0	4.00		
C120/60/15x2.5		15	2.5	5.00		
C140/50/11x1.5	140	50	11	1.5	3.00	
C140/50/13x2.0			13	2.0	4.00	
C140/50/15x2.5			15	2.5	5.00	
C140/55/20x1.5		55	20	1.5	3.32	
C140/55/22x2.0			22	2.0	4.43	
C140/60/15x1.5		60	15	1.5	3.32	
C140/60/17x2.0			17	2.0	4.43	
C140/65/18x1.5		65	18	1.5	3.52	
C140/65/20x2.0			20	2.0	4.69	
C140/70/21x1.5		70	21	1.5	3.72	
C140/70/23x2.0			23	2.0	4.96	
C140/70/25x2.5			25	2.5	6.20	
C150/50/20x1.5			150	50	20	1.5
C150/50/22x2.0		22			2.0	4.43
C150/55/15x1.5	55	15		1.5	3.32	
C150/55/17x2.0		17		2.0	4.43	
C150/60/18x1.5	60	18		1.5	3.52	
C150/60/20x2.0		20		2.0	4.69	
C150/65/13x1.5	65	13		1.5	3.52	
C150/65/15x2.0		15		2.0	4.69	
C150/70/16x1.5	70	16		1.5	3.72	
C150/70/18x2.0		18		2.0	4.96	
C150/70/20x2.5	20	2.5		6.20		
C160/50/15x1.5	160	50		15	1.5	3.32
C160/50/17x2.0				17	2.0	4.43
C160/55/18x1.5				55	18	1.5
C160/55/20x2.0			20		2.0	4.69
C160/60/21x1.5		60	21	1.5	3.72	
C160/60/23x2.0			23	2.0	4.96	
C160/60/25x2.5			25	2.5	6.20	
C160/65/16x1.5			65	16	1.5	3.72
C160/65/18x2.0		18		2.0	4.96	
C160/65/20x2.5		70	20	2.5	6.20	
C160/70/11x1.5			11	1.5	3.72	
C160/70/21x1.5		70	21	1.5	3.96	
C160/70/13x2.0			13	2.0	4.96	
C160/70/23x2.0			23	2.0	5.28	
C160/70/15x2.5			15	2.5	6.20	
C160/70/25x2.5		25	2.5	6.60		
C170/60/16x1.5		170	60	16	1.5	3.72
C170/60/18x2.0				18	2.0	4.96
C170/60/20x2.5				20	2.5	6.20
C180/60/21x1.5				60	21	1.5
C180/60/23x2.0			23		2.0	5.28
C180/60/25x2.5			65	25	2.5	6.60
C180/65/16x1.5				16	1.5	3.96
C180/65/18x2.0			70	18	2.0	5.28
C180/65/20x2.5	20			2.5	6.60	
C180/70/19x1.5	70		19	1.5	4.14	
C180/70/21x2.0			21	2.0	5.52	
C180/70/23x2.5			23	2.5	6.90	
C200/50/11x1.5			200	50	11	1.5
C200/50/13x2.0	13				2.0	4.96
C200/50/15x2.5	15	2.5			6.20	
C200/55/16x1.5	55	16		1.5	3.96	
C200/55/18x2.0		18		2.0	5.28	
C200/55/20x2.5		20		2.5	6.60	
C200/60/19x1.5	60	19		1.5	4.14	
C200/60/21x2.0		21		2.0	5.52	
C200/60/23x2.5		23		2.5	6.90	
C200/60/21x2.0		60		21	2.0	5.52
C200/60/23x2.5	23			2.5	6.90	

Seção Section	h (mm)	b (mm)	c (mm)	t _{nom} (mm)	P (kg/m)	
C200/65/14x1.5	200	65	14	1.5	4.14	
C200/65/16x2.0			16	2.0	5.52	
C200/65/18x2.5			18	2.5	6.90	
C200/70/21x1.5		70	21	1.5	4.44	
C200/70/23x2.0			23	2.0	5.92	
C200/70/25x2.5			25	2.5	7.40	
C220/55/14x1.5	220	55	14	1.5	4.14	
C220/55/16x2.0			16	2.0	5.52	
C220/55/18x2.5			18	2.5	6.90	
C220/60/21x1.5		60	21	1.5	4.44	
C220/60/23x2.0			23	2.0	5.92	
C220/60/25x2.5			25	2.5	7.40	
C220/65/16x1.5		65	16	1.5	4.44	
C220/65/18x2.0			18	2.0	5.92	
C220/65/20x2.5			20	2.5	7.40	
C220/70/11x1.5		70	11	1.5	4.44	
C220/70/13x2.0			13	2.0	5.92	
C220/70/15x2.5			15	2.5	7.40	
C225/80/16x1.5	225	80	16	1.5	4.86	
C225/80/18x2.0			18	2.0	6.48	
C225/80/20x2.5			20	2.5	8.10	
C225/80/22x3.0		22	3.0	9.72		
C225/80/26x4.0		26	4.0	12.96		
C240/55/16x1.5		240	55	16	1.5	4.44
C240/55/18x2.0	18			2.0	5.92	
C240/55/20x2.5	20			2.5	7.40	
C240/60/13x2.0	60		13	2.0	5.92	
C240/60/15x2.5			15	2.5	7.40	
C240/70/19x1.5			70	19	1.5	4.86
C240/70/21x2.0	21			2.0	6.48	
C240/70/23x2.5	23			2.5	8.10	
C250/60/24x1.5	250		60	24	1.5	4.86
C250/60/26x2.0				26	2.0	6.48
C250/60/28x2.5				28	2.5	8.10
C250/65/19x1.5			65	19	1.5	4.86
C250/65/21x2.0		21		2.0	6.48	
C250/65/23x2.5		23		2.5	8.10	
C250/70/14x1.5	250	70	14	1.5	4.86	
C250/70/16x2.0			16	2.0	6.48	
C250/70/18x2.5			18	2.5	8.10	
C260/60/19x1.5		60	19	1.5	4.86	
C260/60/21x2.0			21	2.0	6.48	
C260/60/23x2.5			23	2.5	8.10	
C260/65/14x1.5	260	65	14	1.5	4.86	
C260/65/16x2.0			16	2.0	6.48	
C260/65/18x2.5			18	2.5	8.10	
C260/70/19x1.5		70	19	1.5	5.10	
C260/70/21x2.0			21	2.0	6.80	
C260/70/23x2.5			23	2.5	8.50	
C275/80/25x2.5	275	80	25	2.5	9.30	
C275/80/25x3.0			25	3.0	11.04	
C280/60/19x1.5			280	60	19	1.5
C280/60/21x2.0	21	2.0			6.80	
C280/60/23x2.5	23	2.5			8.50	
C280/65/14x1.5	65	14		1.5	5.10	
C280/65/16x2.0		16		2.0	6.80	
C280/65/18x2.5		18		2.5	8.50	
C300/70/21x1.5	300	70	21	1.5	5.64	
C300/70/23x2.0			23	2.0	7.52	
C300/70/23x2.5			23	2.5	9.30	
C300/70/27x3.0		70	27	3.0	11.28	
C300/75/18x2.5			75	18	2.5	9.30
C300/75/22x3.0				22	3.0	11.28
C300/80/25x3.0	80	25		3.0	11.64	
C325/65/14x1.5		325	65	14	1.5	5.64
C325/65/16x2.0				16	2.0	7.52
C325/65/15x2.5	15			2.5	9.30	
C325/65/20x3.0	20			3.0	11.28	

Outras dimensões sob consulta · Other dimensions on demand

APLICAÇÃO

Perfil de separação entre o revestimento de cobertura existente e novo

FIG A – a reentrância no banzo inferior permite acomodar os parafusos do revestimento existente

FIG B – banzo superior para fixar o revestimento novo e furação no banzo inferior para fixar o perfil G40 à estrutura existente

APPLICATION

Separation section between existing and new roof cladding

FIG A – the recess in the lower flange allows to accommodate the bolts from the existing cladding

FIG B – upper flange to fix the new cladding and holes in the lower flange to fix section G40 to the existing structure

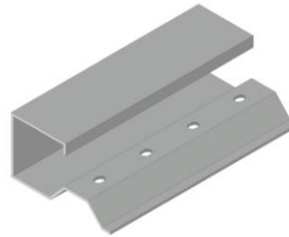
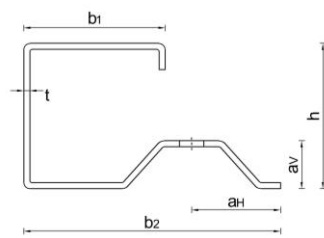
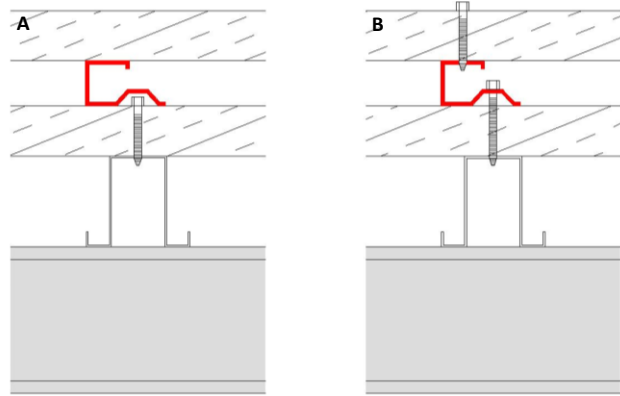

Seção Section	h (mm)	b ₁ (mm)	b ₂ (mm)	t _{nom} (mm)	∅ (mm)	a _v (mm)	a _H (mm)	P (kg/m)
G40	38	35	64	1.5	9.0x15.0 // 50	15	22	1.66



TUBULAR

APLICAÇÃO

Viga e pilar para a execução de pisos, escadas e coberturas

O perfil TUBULAR é composto por 2 secções ligadas por parafusos M8

APPLICATION

Beam and column for the execution of floors, mezzanine, stairs and roofs

Section TUBULAR is the result of 2 sections connected by M8 bolts

Seção Section	h (mm)	b (mm)	t _{nom} (mm)	P (kg/m)
Tubular 170	170	100	2.5	12.40
Tubular 230	230			14.80
Tubular 265	265			16.20

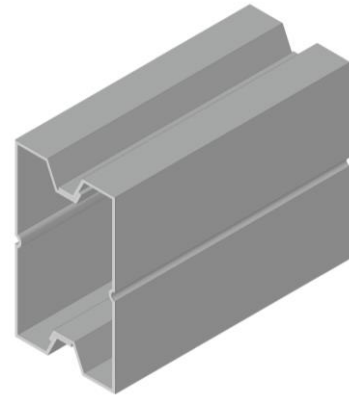
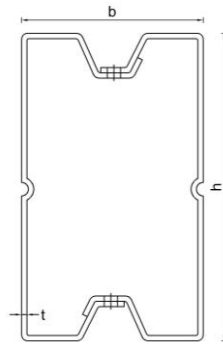



HABITAÇÃO
RESIDENCE

APLICAÇÃO

Pisos, coberturas e platibandas

- (1) cordas definidas por perfil RBF ou CP
- (2) diagonais definidas por perfil UB40 ou UB60
- (3) a calha no banzo superior do perfil RBF permite a ligação a outros perfis através de parafuso rômico

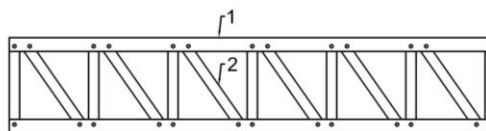

APPLICATION

Floors, roof and parapets

- (1) chords in section RBF or section CP
- (2) diagonals in section UB40 or UB60
- (3) the upper flange of RBF has a channel that allows the connection to other sections through rhombic bolts

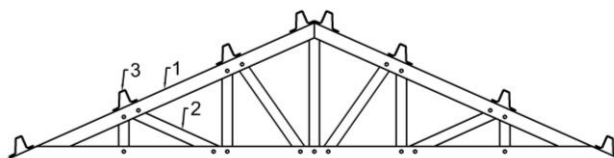

COBERTURA VÃO APROVEITADO · ATTIC ROOF

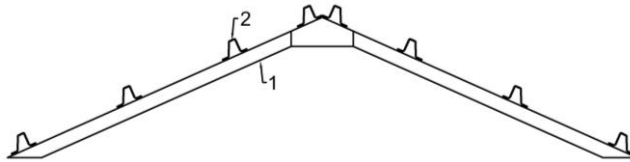

APLICAÇÃO

Estrutura de cobertura com vão aproveitado

(1) viga definida pelas seguintes alternativas: TUBULAR, VIGA TRELIÇADA, RBF, RBF & OB35/40 ou RBF & UB120

(2) ripa definida pelas seguintes alternativas: OB40/20 ou OB60/20 para telha cerâmica, OB100, ÔMEGA ou ÔMEGA R para painel de cobertura

APPLICATION

Structure for attic roof

(1) beam defined by the following alternatives: TUBULAR, TRUSS BEAM, RBF, RBF & OB35/40 or RBF & UB120

(2) purlin defined by the following alternatives: OB40/20 or OB60/20 for ceramic roof tiles, OB100, OMEGA or OMEGA R for roof panel



RBF

APLICAÇÃO

Viga treliçada, estrutura de cobertura, estrutura de suporte de painéis fotovoltaicos

Calha no banzo superior do perfil RBF permite a ligação a outros perfis através de parafuso rômbo

APPLICATION

Truss beam, roof structure, support structure for photovoltaic panels

The channel on the upper flange of section RBF allows the connection to other sections through rhombic bolts

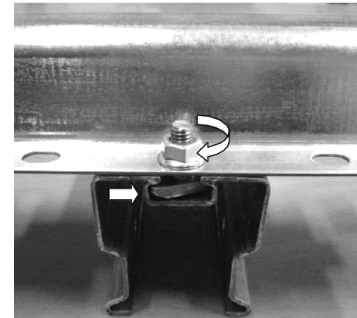
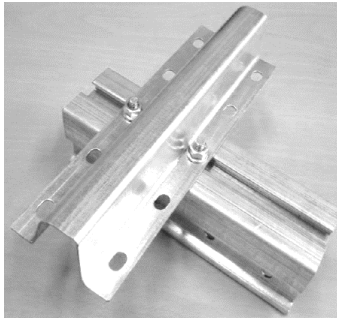
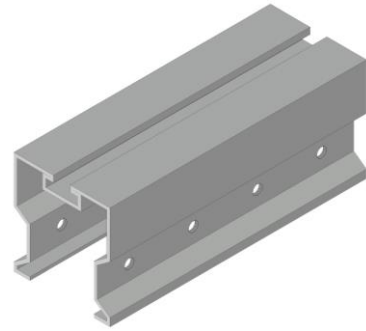
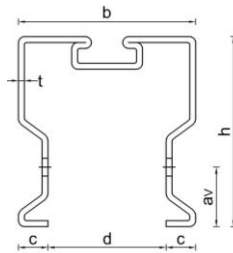

Estrutura de cobertura com fixação das ripas em qualquer posição simplificando a montagem em obra
Roof structure with purlin connection in any position simplifying the construction on site

RBF & OB35/40

APLICAÇÃO

Estrutura de cobertura com aproveitamento do vão

Perfil composto pelas secções RBF e OB35/40 ligadas por parafusos M8

APPLICATION

Attic roof

Section composed by sections RBF and OB35/40 connected by M8 bolts

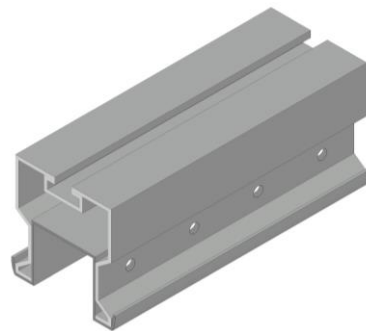
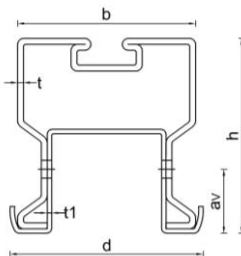

RBF & UB120

APLICAÇÃO

Estrutura de cobertura com aproveitamento do vão

Perfil composto pelas secções RBF e UB120 ligadas por parafusos M8

APPLICATION

Attic roof

Section composed by sections RBF and UB120 connected by M8 bolts

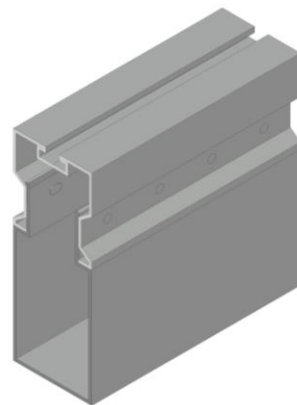
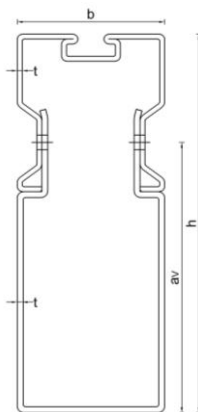

Seção Section	h (mm)	b (mm)	c (mm)	d (mm)	t _{nom} (mm)	∅ (mm)	av (mm)	P (kg/m)
RBF	64	60	10	40	2.0	9.0 // 50	20	3.58
RBF & OB35/40	66	60	--	65	2.0 / 1.5	9.0x13.0 // 50	22	5.24
RBF & UB120	154	60	--	--	2.0	9.0 // 50	110	8.54

CP

APLICAÇÃO

Viga treliçada, estrutura de cobertura

APPLICATION

Truss beam, roof structure

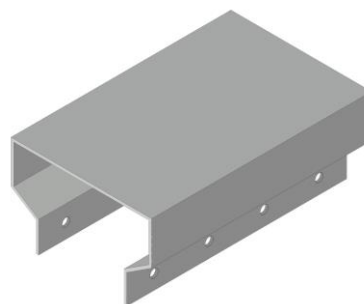
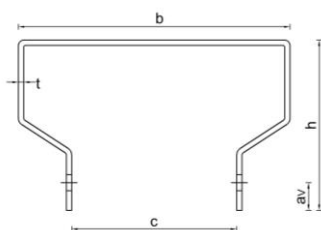

UB40 · UB60

APLICAÇÃO

Diagonal de viga treliçada

Perfil UB40 com perfil RBF

Perfil UB60 com perfil CP

APPLICATION

Diagonal of truss beam

Section UB40 with section RBF

Section UB60 with section CP

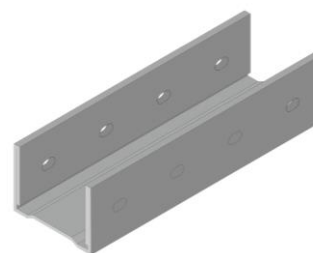
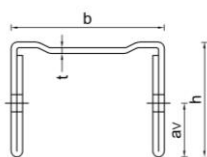

Seção Section	h (mm)	b (mm)	c (mm)	t _{nom} (mm)	∅ (mm)	av (mm)	P (kg/m)
CP	60	96	58	2.0	9.0 // 50	20	3.58
UB40	30	40	--	1.5	9.0x13.0 // 50	20	1.66
UB60	30	58	--	1.5	9.0x13.0 // 50	20	1.92



APLICAÇÃO

Perfis para suporte de telha cerâmica

- OB20/20, OB20/10 e OB30/10 como sub-ripa
- OB30/10 com furos nas almas para ventilação
- OB40/20 e OB60/20 como ripa

APPLICATION

Sections for the support of roof tile

- OB20/20, OB20/10 and OB30/10 as sub-purlin
- OB30/10 with holes in the web for ventilation
- OB40/20 and OB60/20 as purlin

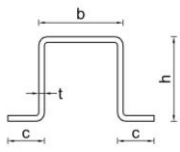
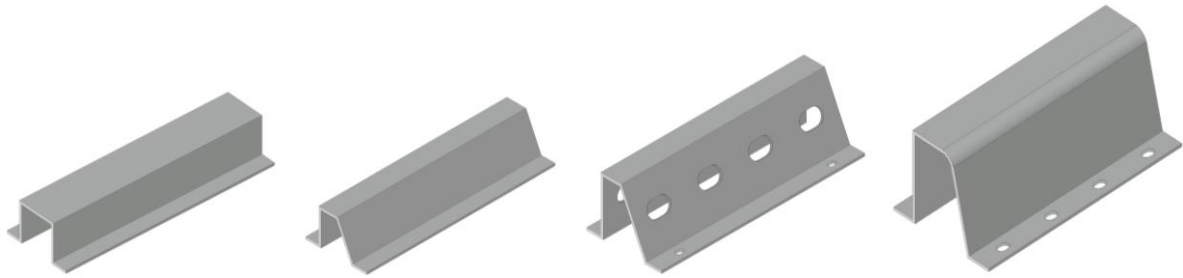

OB20/20

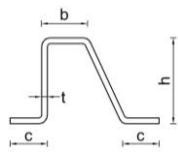

OB20/10

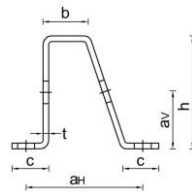

OB30/10

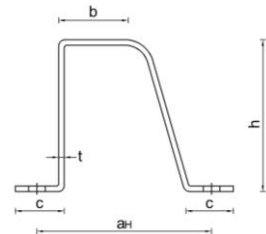

OB40/20 · OB60/20

Seção Section	h (mm)	b (mm)	c (mm)	t _{nom} (mm)	∅ (mm)	a _H (mm)	a _V (mm)	P (kg/m)
OB20/20x0.6	20	20	16	0.6	--	--	--	0.42
OB20/20x0.8				0.8				0.56
OB20/10x0.6	20	10	15	0.6	--	--	--	0.39
OB20/10x0.8				0.8				0.52
OB20/10x1.0				1.0				0.66
OB30/10x0.8	30	10	16	0.8	H: 6.0x10.0 // 300 V: 14.0x20.0 // 100	46	15	0.67
OB30/10x1.0				1.0				0.84
OB40/20x1.5	40	20	20	1.5	13.0x9.0 // 50	60	--	1.66
OB60/20x1.2	55			1.2				1.70



APLICAÇÃO

Estrutura de paredes, pisos e cobertura composta por perfis C (montantes) & U (canais)
 Comprimento e furação de acordo com os requisitos



APPLICATION

Walls, floors and roofs structure composed by sections C (vertical) & U (channel)
 Length and holes according to specifications

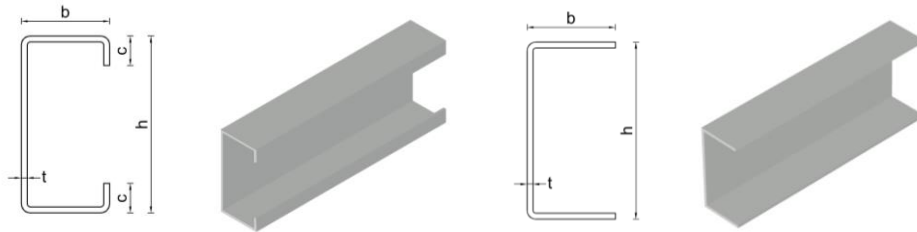

Seção Section	h (mm)	b (mm)	c (mm)	t _{nom} (mm)	P (kg/m)
C90/43/15x1.5	90	43	15	1.5	2.23
C150/43/15x1.5	150			1.5	3.00
C200/43/15x2.0	200			2.0	4.80
C250/43/15x2.5	250			2.5	6.90
U93/40x1.5	93	40	-	1.5	2.00
U153/40x1.5	153			1.5	2.72
U204/41x2.0	204	41		2.0	4.43
U255/43x2.5	255	43		2.5	6.60

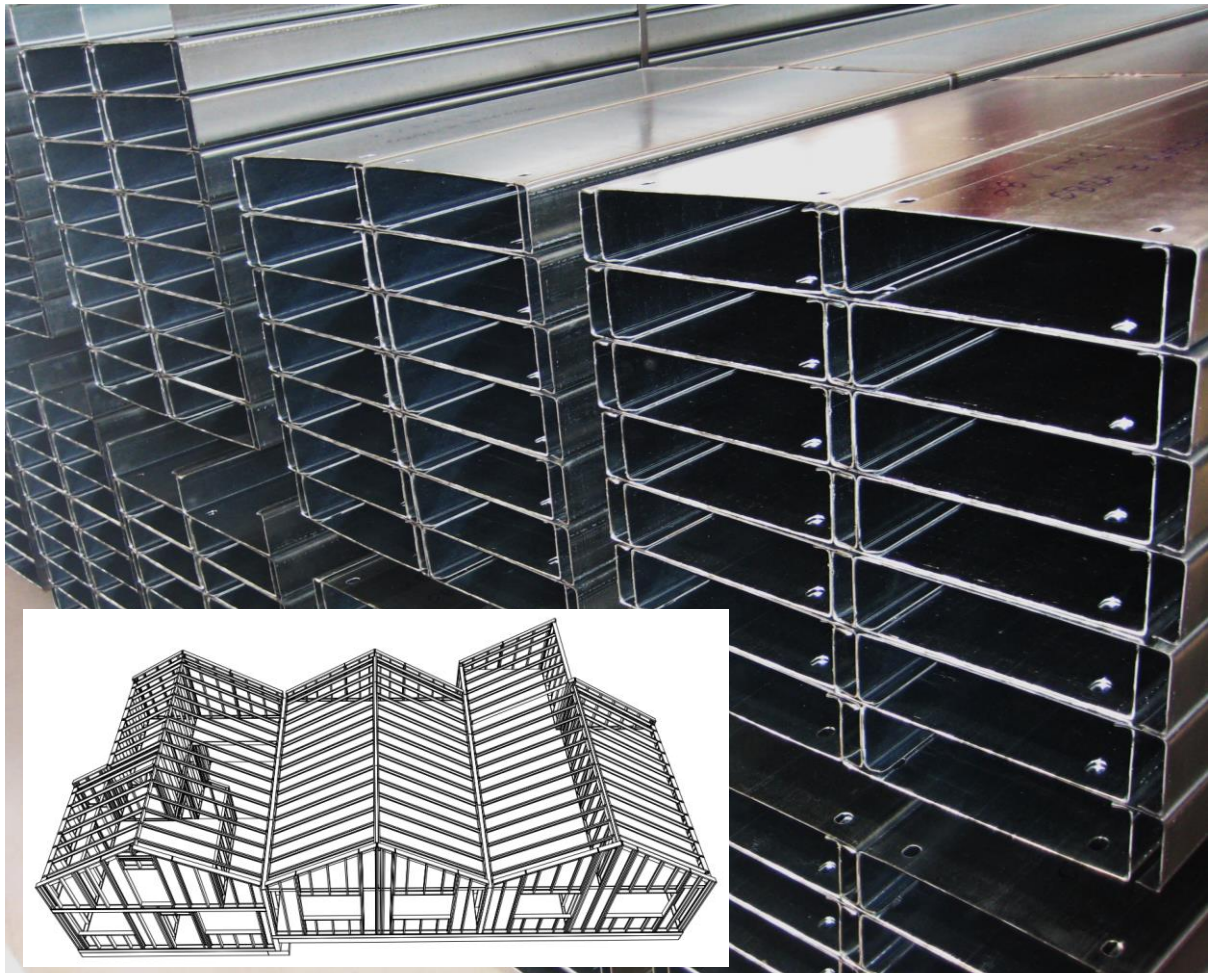



ENERGIA
ENERGY

PERFIS PARA PAINÉIS FOTOVOLTAICOS SECTIONS FOR PHOTOVOLTAIC PANELS

APLICAÇÃO

Estrutura de suporte para painéis fotovoltaicos definida pelos perfis: (1) RBF, (2) UB40, (3) UF40/40 e USF35/45 e (4) CF

- UF40/40 – banzo superior preparado para porca M10 com mola para fixar perfil intermédio de ligação aos painéis fotovoltaicos
- USF35/45 – perfil de ligação para garantir continuidade entre UF40/40
- CF – perfil para passagem de cabos

APPLICATION

Support structure for photovoltaic panels defined by sections: (1) RBF, (2) UB40, (3) UF40/40 and USF34/45 and (4) CF

- UF40/40 – upper flange prepared for M10 nut with Spring to fix intermediate section of connection to photovoltaic panels
- USF35/45 – connection section between UF40/40 to guarantee continuity
- CF – section for cable running

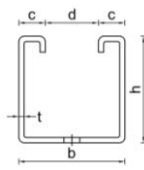
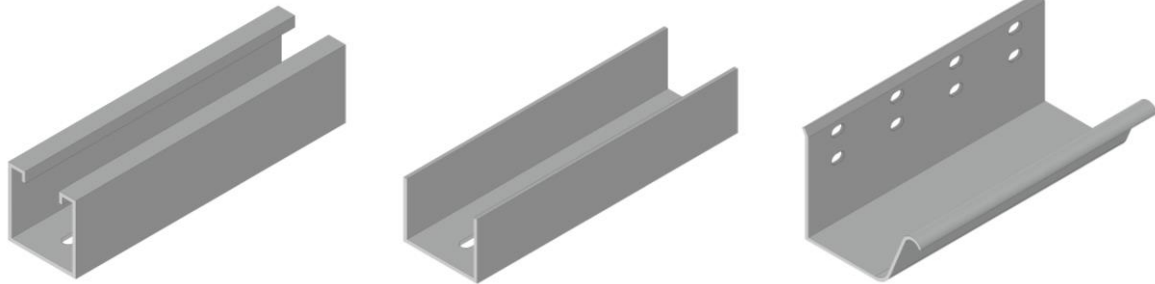
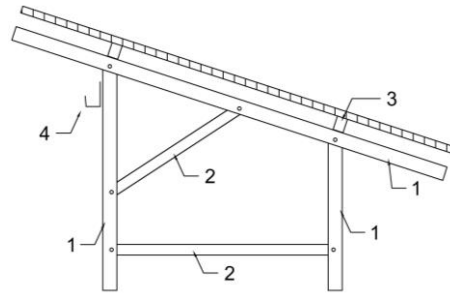

UF40/40

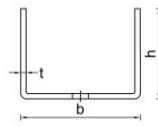

USF34/45

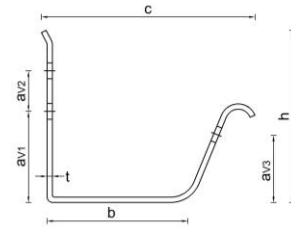

CF

Seção Section	h (mm)	b (mm)	c (mm)	t _{nom} (mm)	∅ (mm)	a _{v1} (mm)	a _{v2} (mm)	a _{v3} (mm)	P (kg/m)
UF40/40	40	40	10	2.0	9.0x24.0 // 50	--	--	--	2.08
USF34/45	34	45	--	2.0	9.0x24.0 // 50	--	--	--	1.68
CF	70	52	86	1.2	9.0x13.0 // 50	35	20	30	1.70



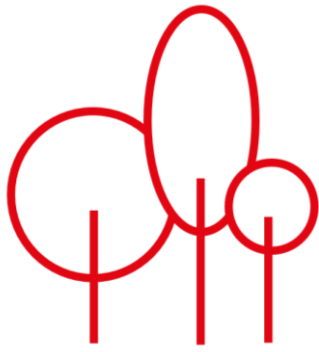

AGRICULTURA
AGRICULTURE

PERFIS PARA ESTUFAS · SECTIONS FOR GREENHOUSES

APLICAÇÃO

Perfis para clipar plástico: HE40/38, CE18/28, UE40/25
 Caleiro para escoamento de água

APPLICATION

Sections to clip plastic: HE40/38, CE18/28, UE40/25
 Gutter for water drainage

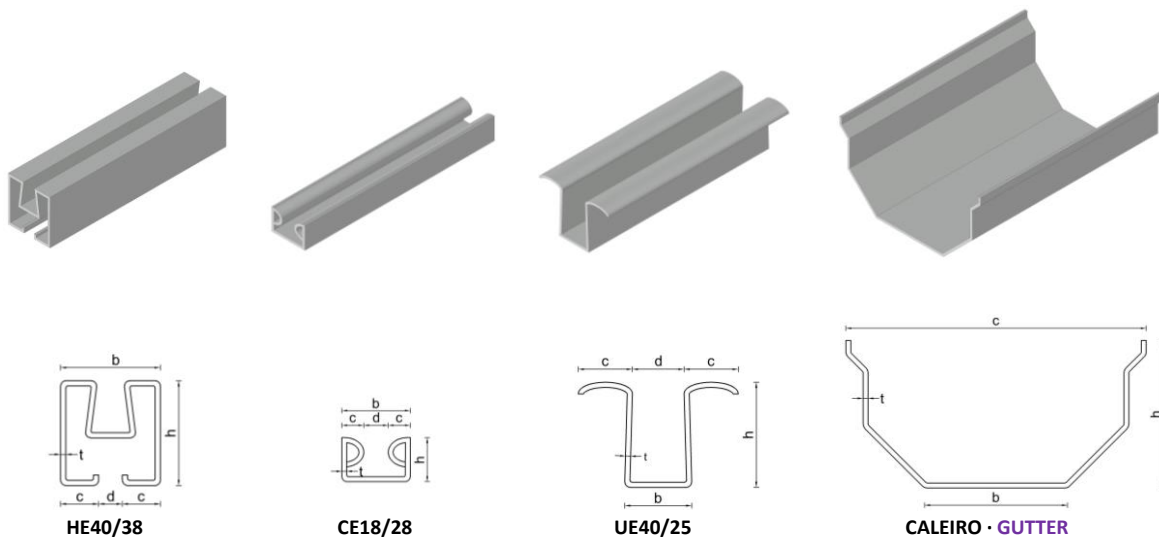

Seção Section	h (mm)	b (mm)	c (mm)	d (mm)	t _{nom} (mm)	P (kg/m)
HE40/38	147	142	295	--	2.0	7.92
CE18/28	40	38	14	10	1.2	1.70
UE40/25	18	28	9	10	1.2	0.84
CALEIRO · GUTTER	40	25	20	21	1.5	1.56



ESTACA · STAKE

APLICAÇÃO

Estaca para diferentes culturas agrícolas
Furos tipo Z nas almas com 100 mm de afastamento, 50 mm da extremidade, para fixação de arame

APPLICATION

Stake for different agriculture cultures
Z type holes in the webs with 100 mm spacing, 50 mm from the edge, for wire support

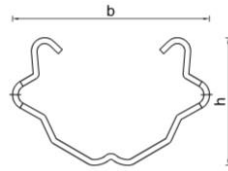

ESTACA A STAKE A

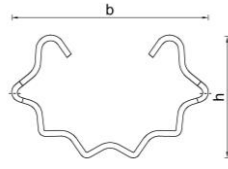
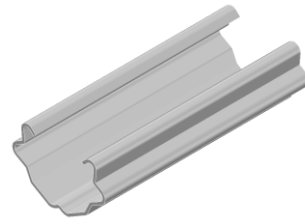

ESTACA B STAKE B

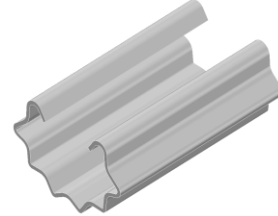

CABECEIRA · HEADSTAKE

APLICAÇÃO

Estaca de cabeceira para diferentes culturas agrícolas

Furos redondo 8 mm na alma com 100 mm de afastamento para fixação de arame

APPLICATION

Headstake for different agriculture cultures
Circular hole with 8 mm in the web with 100 mm spacing for wire support

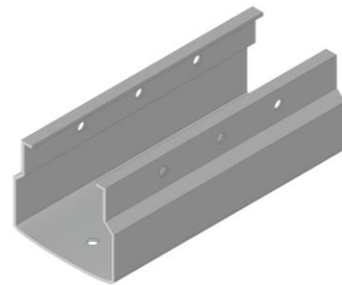
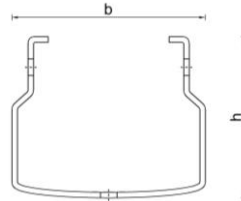

Seção Section	h (mm)	b (mm)	t _{nom} (mm)	P (kg/m)	Esquema de Furação Hole Scheme	L (m)	f (mm)	g (m)	n (un)	∅ (mm)	a (mm)	
ESTACA STAKE	34	52	1.2	1.04		Lateral Side	1.50	50	0.70	8	Z16.0	100
			1.5	1.30			2.00					
			1.8	1.56			2.20					
CABECEIRA HEADSTAKE	50	42	2.0	2.08		Base Bottom	2.20	50	1.32	12	8.0	120
						Lateral Side	2.40					
						2.60	100					



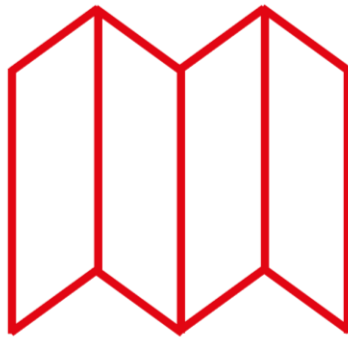

PORTÕES
GATES

PERFIL PORTÃO DE CORRER · SECTION FOR SLIDING GATE

APLICAÇÃO

Perfil guia para portão de correr

APPLICATION

Rail section for sliding gate

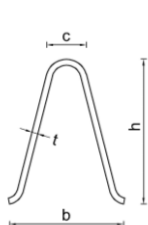

GUIA DE CHUMBAR · CEMENT FIXING RAIL

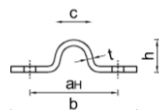
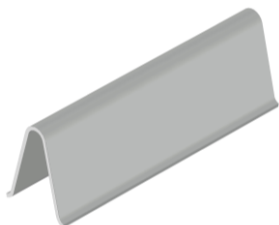

GUIA DE APARAFUSAR · SURFACE FIXING RAIL

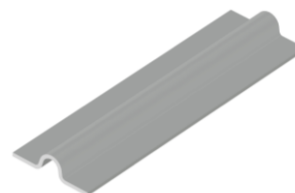

Seção Section	Roda Wheel	h (mm)	b (mm)	c (mm)	t _{nom} (mm)	a _H (mm)	φ (mm)	P (kg/m)
GUIA DE CHUMBAR CEMENT FIXING RAIL	Ø16 mm	60	48	16	2.5	--	--	2.48
	Ø20mm	56	48	20	2.5	--	--	2.48
GUIA DE APARAFUSAR SURFACE FIXING RAIL	Ø16 mm	14	54	16	2.5	38	9.0 // 500	1.24

PORTÕES DE FOLE · FOLDING GATES

APLICAÇÃO

Portão de segurança para edifícios industriais ou residenciais
Portão em chapa de aço galvanizada ou plastificada com guias superior e inferior e fechadura de linguete com gancho

APPLICATION

Security gate for industrial or residential buildings
Galvanized or plastic-coated steel sheet gate with upper and lower rails and bolt lock hook

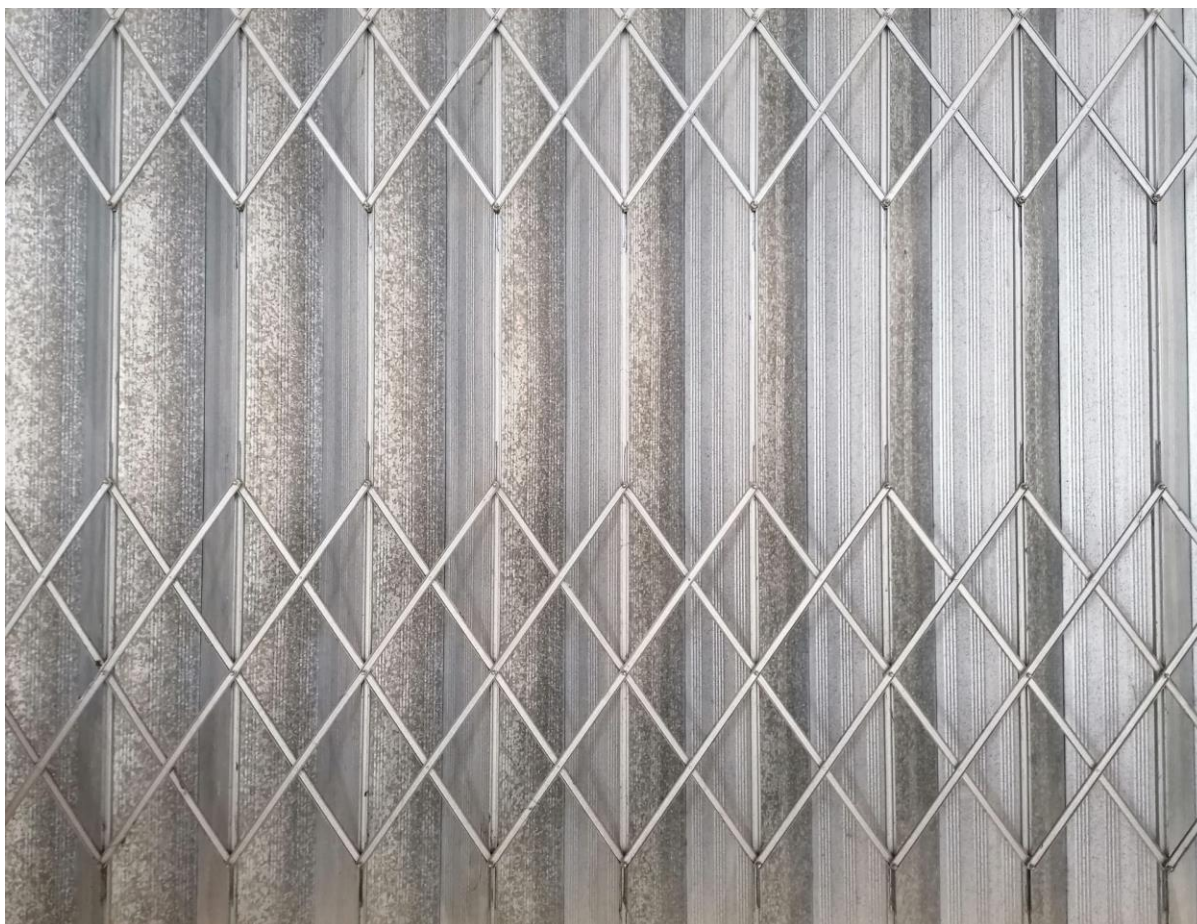

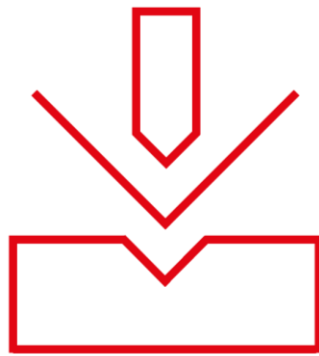

CORTE E QUINAGEM
CUTTING AND PRESS BRAKING

APLICAÇÃO

Perfis personalizados em chapa de aço até 12 m de comprimento
Comprimento e furação de acordo com os requisitos

APPLICATION

Custom-made steel sections until 12 m of length
Length and holes according to specifications

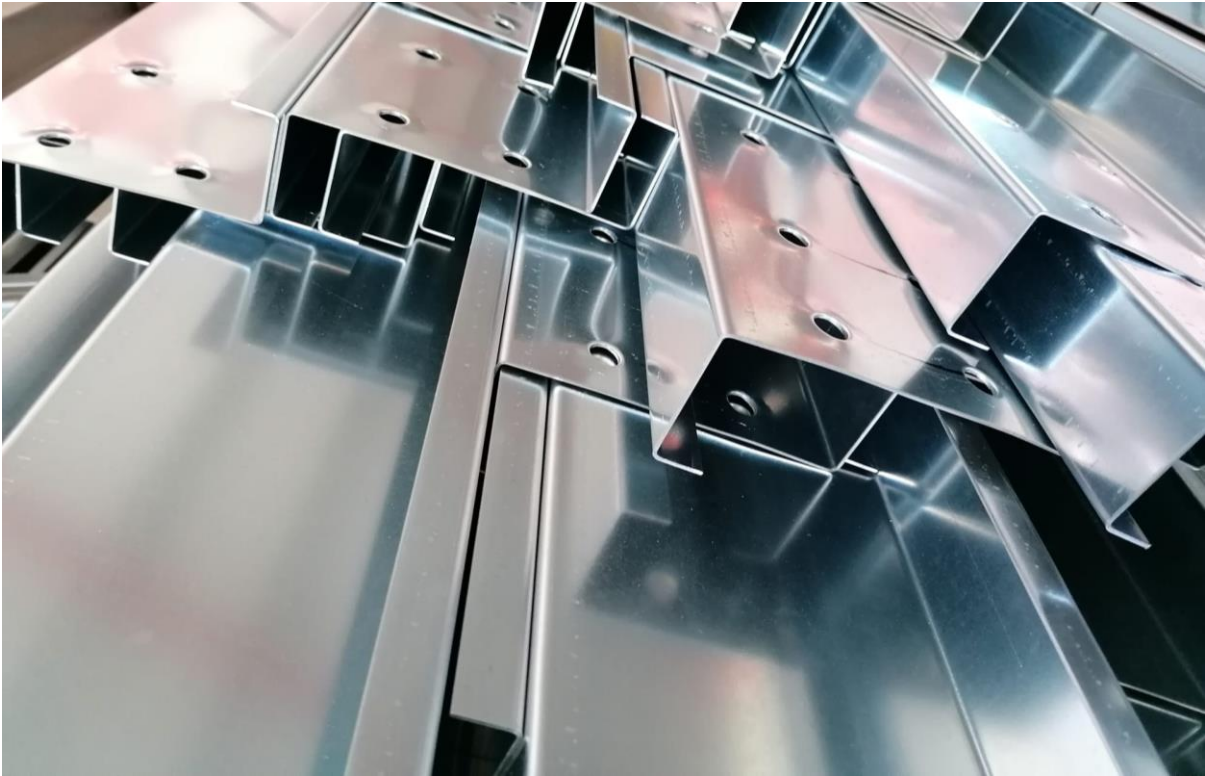

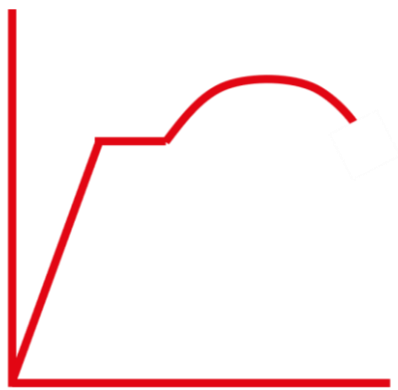

PROPRIEDADES DOS MATERIAIS
MATERIAL PROPERTIES

AÇO GALVANIZADO · GALVANIZED STEEL

EN 10346

Aço ao carbono de qualidade estrutural com revestimento de zinco por imersão contínua a quente
Continuous hot dip zinc coated carbon steel sheet of structural quality

Classe de Aço Steel Grade	Tensão de cedência Basic yield strength	Tensão de rotura Tensile strength	Revestimento Coating	Espessura · Thickness (µm)	
	f_{yb} (MPa)	f_u (MPa)		Valor típico Typical Value	Intervalo Range
S220GD+Z	220	300	Z200	14	10 – 20
S280GD+Z	280	360	Z275	20	13 – 27
S320GD+Z	320	390	ZM310	24	18 – 31
S350GD+Z	350	420	Z – Zinco, ZM – Zinco-Magnésio		

AÇO INOXIDÁVEL · STAINLESS STEEL

EN 10088

Aço inoxidável austenítico
Austenitic stainless steel

Classe de Aço Steel Grade	Tensão de cedência Basic yield strength	Tensão de rotura Tensile strength
	f_{yb} (MPa)	f_u (MPa)
304 2B (1.4301)	230	540
316 2B (1.4401)	240	530

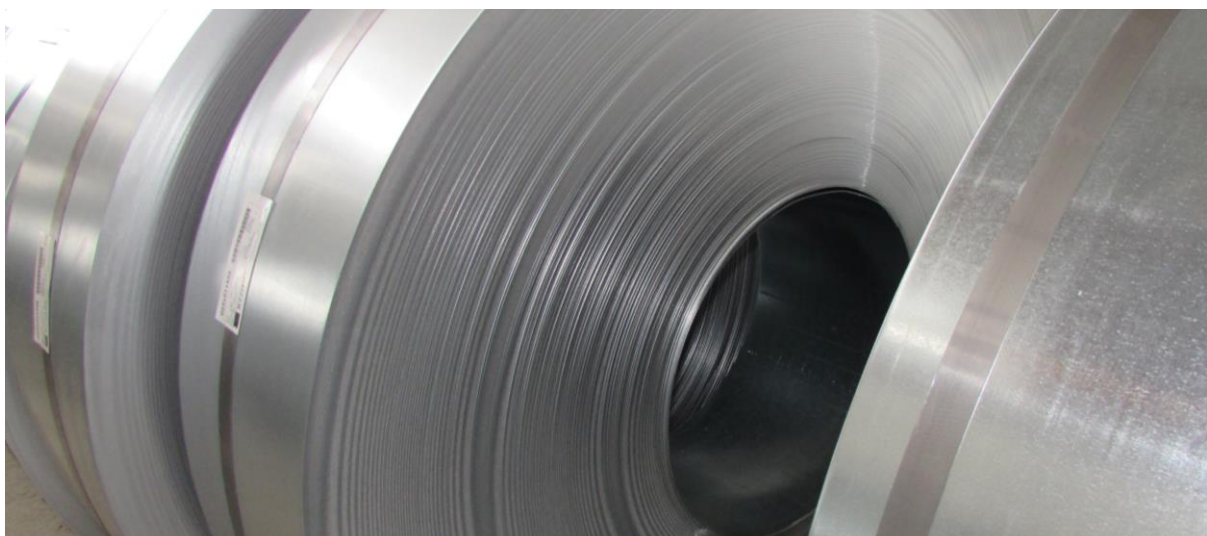
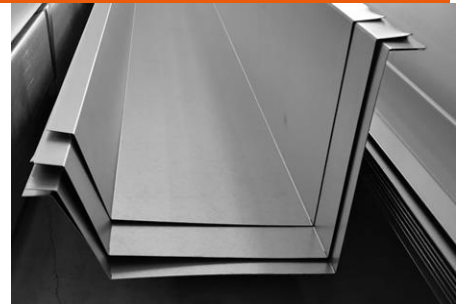



Rua Bartolomeu Dias, 8
Parque Industrial Manuel da Mota
3100-354 Pombal
Portugal

(+351) 236 212 418
custo de chamada para a rede fixa nacional
geral@barraferros.com



WWW.BARRAFERROS.COM

