

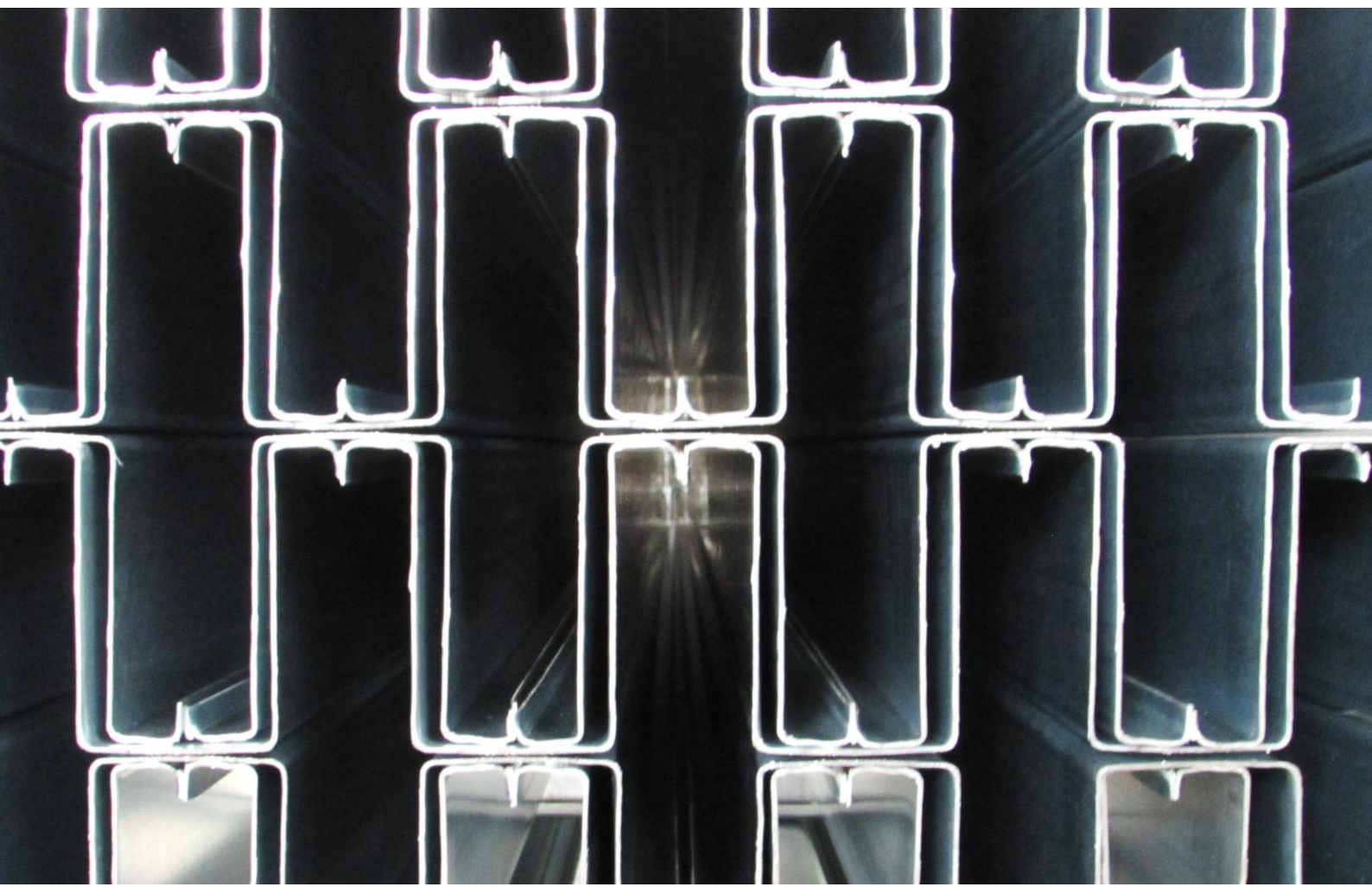

BARRALFERROS



| | |
|---|-----------|
| BARRAFERROS, LDA. | 3 |
| SETORES DE ATIVIDADE · SECTORES OF ACTIVITY | 4 |
| CERTIFICAÇÃO · CERTIFICATION | 6 |
| PRÉMIOS · AWARDS | 7 |
| PRODUTOS · PRODUCTS | 8 |
| INDÚSTRIA · INDUSTRY | 8 |
| OMEGA OB | 9 |
| OMEGA | 10 |
| OMEGA R | 10 |
| SUPORTE · SUPPORT | 10 |
| Z | 11 |
| C | 12 |
| G40 | 13 |
| TUBULAR | 14 |
| HABITAÇÃO · RESIDENCE | 15 |
| VIGA TRELIÇADA · TRUSS BEAM | 16 |
| COBERTURA COM VÃO APROVEITADO · ATTIC ROOF | 17 |
| RBF | 18 |
| RBF & OB35/40 | 18 |
| RBF & UB120 | 18 |
| CP | 19 |
| UB40 & UB60 | 19 |
| RIPAS · PURLINS | 20 |
| C & U (ESTRUTURA EM AÇO LEVE · LIGHT STEEL FRAMING) | 21 |
| ENERGIA · ENERGY | 22 |
| PERFIS PARA PAINÉIS FOTOVOLTAICOS SECTIONS FOR PHOTOVOLTAIC PANELS | 23 |
| AGRICULTURA · AGRICULTURE | 24 |
| PERFIS PARA ESTUFAS · SECTIONS FOR GREENHOUSES | 25 |
| ESTACA · STAKE | 26 |
| CABECEIRA · HEADSTAKE | 26 |
| PORTÕES · GATES | 27 |
| PERFIL PORTÃO DE CORRER · SECTION FOR SLIDING GATE | 28 |
| PORTÕES DE FOLE · FOLDING GATES | 28 |
| CORTE E QUINAGEM · CUTTING AND PRESS BRAKING | 29 |
| PROPRIEDADES DOS MATERIAIS · MATERIAL PROPERTIES | 30 |

EMPRESA ESPECIALIZADA NO DESIGN, DESENVOLVIMENTO E FABRICO DE PERFIS EM AÇO ENFORMADO A FRIO



Os perfis em aço enformados a frio apresentam muitas vantagens quando comparados com outras soluções, nomeadamente a boa relação entre a resistência e o peso, fabrico industrial rápido e limpo, facilidade de elevação e montagem em obra.

A Barraferros com o design, desenvolvimento e fabrico de perfis em aço enformado a frio, por perfilagem e quinagem, para os setores da construção, reabilitação, energia e agricultura, contribui para projetos mais económicos, sustentáveis e inteligentes.



perfis
em aço
steel
sections



mm de
espessura
mm of
thickness



aço estrutural
EN 10346
structural steel
EN 10346



aço inoxidável
EN 10088
stainless steel
EN 10088

COMPANY SPECIALIZED IN THE DESIGN, DEVELOPMENT AND PRODUCTION OF COLD FORMED STEEL SECTIONS



Cold-formed steel sections have many advantages when compared to other solutions, namely the good ratio between strength and weight, fast and clean industrial production, ease of lifting and assembly on site.

Barraferros, with the design, development and manufacture of cold-formed steel sections, by profiling and press bending, for the construction, retrofitting, energy, and agriculture sectors, contributes to more economical, sustainable, and intelligent projects.



INDÚSTRIA

perfis para
estrutura de
suporte de
cobertura e fachada

INDUSTRY

sections for roof
and facade
cladding structure



HABITAÇÃO

perfis para pilares,
vigas, paredes,
pisos e cobertura

RESIDENCE

sections for
columns, beams,
walls, floors and
roof



ENERGIA

perfis para
estrutura de
suporte de painéis
fotovoltaicos

ENERGY

sections for
photovoltaic panels
support structure





AGRICULTURA
perfis para culturas
agrícolas e estufas

AGRICULTURE
sections for
agriculture culture
and greenhouses



PORTÕES
portão de fole em
chapa de aço

GATES
steel sheet folding
gate



**CORTE E
QUINAGEM**
perfis
personalizados até
12 m de
comprimento

**CUTTING AND
PRESS BRAKING**
custom-made
sections until 12 m
of length



CERTIFICAÇÃO · CERTIFICATION

| | |
|---|---|
|  | Certificado de Conformidade do Controlo de Produção em Fábrica Certificate of Conformity of Factory Production Control |
| Produto Product | Aço Galvanizado Galvanized Steel |
| Norma Standard | EN 1090-1:2009 + A1:2011 |
| Método de Declaração Declaration Method | 2, 3a |
| Classe de Execução Execution Class | EXC2 (EN 1090-4) |
| Material de Base Base Material | S220GD, S280GD, S320GD, S350GD |
|  | Sistema de Gestão da Qualidade da Organização Organizational Quality Management System |
| Norma Standard | ISO 9001:2015 |
|  | Sistema de Gestão de Saúde e Segurança Ocupacional Occupational Health and Safety Management System |
| Norma Standard | ISO 45001:2018 |



PRÉMIOS · AWARDS

O estatuto PME Líder é um selo de reputação criado pelo IAPMEI para distinguir o mérito das Pequenas e Médias Empresas Portuguesas com desempenho superior, com base nas melhores notações de rating e indicadores económico-financeiros.

The PME Líder status is a seal of reputation created by IAPMEI to distinguish the merit of Small and Medium Sized Portuguese Companies with superior performance, based on the best ratings and economic-financial indicators.

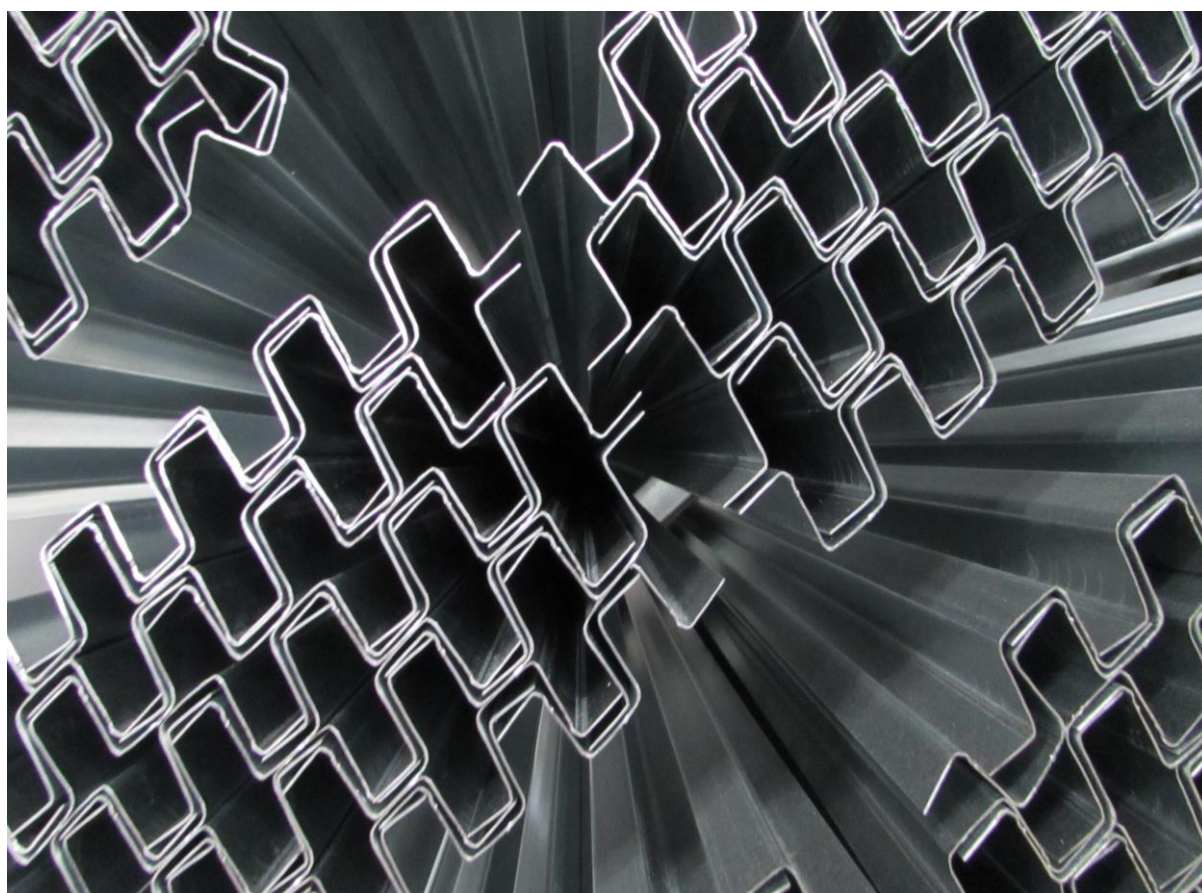



INDÚSTRIA
INDUSTRY

APLICAÇÃO

Estrutura para revestimento de cobertura e fachada (madres)
 Estrutura para piso
 Estrutura para painéis fotovoltaicos

APPLICATION

Structure for roof and facade cladding (purlins and side rails)
 Structure for floor
 Structure for photovoltaic panels

ESPECIFICIDADES

A configuração das secções permite a sobreposição vertical com as seguintes vantagens:

- Aumento da resistência na zona de sobreposição
- Redução do volume do lote de perfis no transporte
- Facilidade de montagem e ligação dos perfis

SPECIFICITIES

The configuration of the sections allows vertical overlap with the following advantages:

- Increase of the resistance in the overlap area
- Reduction of the profile set volume for transport
- Easy installation and connection of profiles on site

Esquema de sobreposição sugerido:

- Vãos internos – comprimento de sobreposição nos apoios igual a 20% do vão, sendo 10% para cada lado do apoio
- Vãos de extremidade – comprimento de sobreposição nos apoios igual a 25% do vão, sendo 10% no vão extremidade e 15% no vão interno adjacente

Suggested overlap scheme:

- Internal spans – overlap length at the supports equal to 20% of the span, 10% for each side of the support
- End spans – overlap length at the supports equal to 25% of the span, being 10% at the end span and 15% at the adjacent internal span

Furações:

- Furos ovais nas abas e almas
- De acordo com os requisitos de projeto

Holes:

- Oval holes in the lower flanges and webs
- According to design specifications

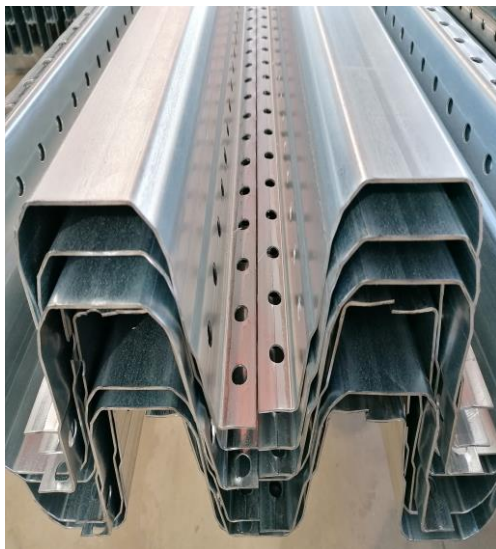
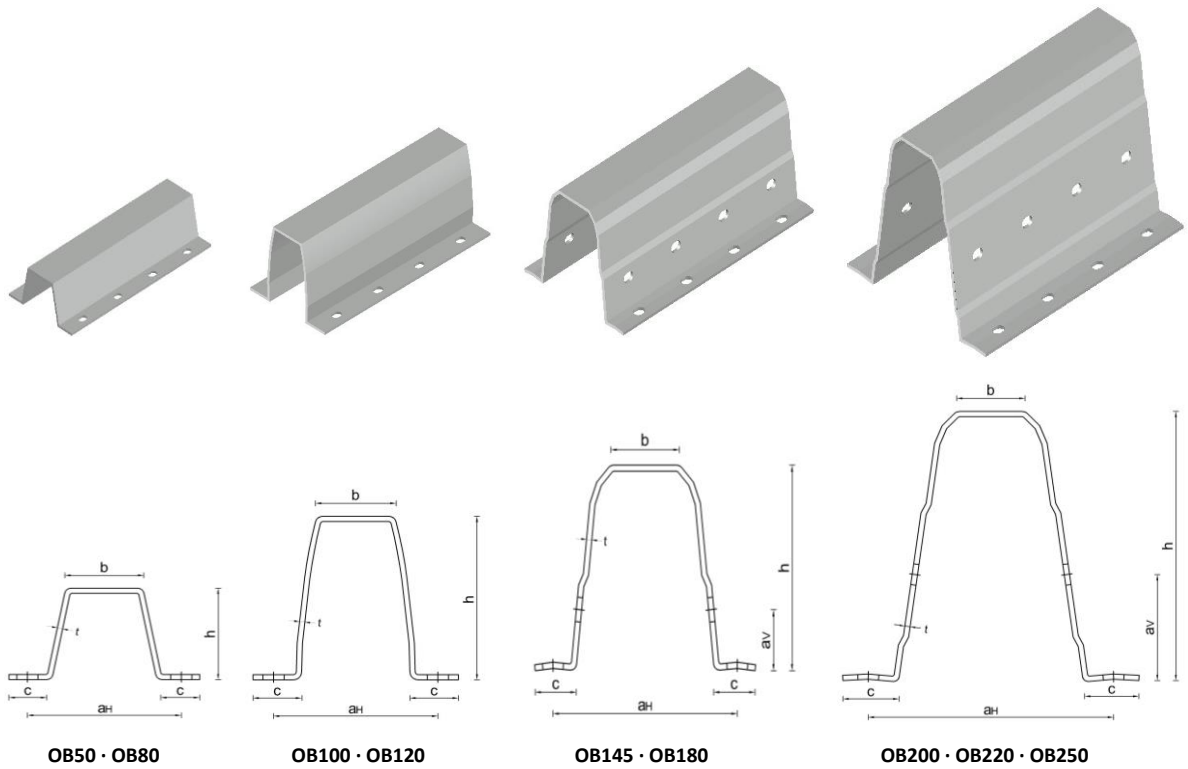

| Seção Section | h (mm) | b (mm) | c (mm) | t _{nom} (mm) | ∅ (mm) | a _H (mm) | a _V (mm) | P (kg/m) | | |
|------------------|-----------|-----------|-----------|--------------------------|------------------|------------------------|------------------------|-------------------|-----|-------|
| OB50x1.2 | 50 | 42 | 22 | 1.2 | 9.0x13.0 //50 | 82 | -- | 1.70 | | |
| OB50x1.5 | | | | 1.5 | | | | 2.12 | | |
| OB80x1.5 | 1.5 | | 3.00 | | | | | | | |
| OB100x1.5 | 1.5 | | 3.52 | | | | | | | |
| OB100x2.0 | 100 | | 30 | 2.0 | | 4.69 | | | | |
| OB120x1.5 | 1.5 | | | 3.96 | | | | | | |
| OB120x2.0 | 120 | | 2.0 | 5.28 | | | | | | |
| OB145x1.5 | 143 | | 56 | 32 | | 1.5 | | 12.5x14.5 //50 | 150 | 37 |
| OB145x2.0 | | 2.0 | | | 6.48 | | | | | |
| OB145x2.5 | | 2.5 | | | 8.10 | | | | | |
| OB180x1.5 | | 1.5 | | | 5.94 | | | | | |
| OB180x2.0 | 183 | 38 | | 2.0 | 7.92 | | | | | |
| OB180x2.5 | 2.5 | | | 9.90 | | | | | | |
| OB200x1.5 | 195 | 44 | | 44 | 1.5 | 200 | 80 | | 80 | 6.30 |
| OB200x2.0 | | | | | 2.0 | | | | | 8.40 |
| OB200x2.5 | | | 2.5 | | 10.50 | | | | | |
| OB220x1.5 | | | 1.5 | | 7.08 | | | | | |
| OB220x2.0 | 220 | | 48 | 2.0 | 9.44 | | | | | |
| OB220x2.5 | 2.5 | | | 11.80 | | | | | | |
| OB250x1.5 | 250 | | 48 | 48 | 1.5 | | 200 | 80 | 80 | 7.86 |
| OB250x2.0 | | | | | 2.0 | | | | | 10.48 |
| OB250x2.5 | | 2.5 | | | 13.10 | | | | | |

OMEGA

APLICAÇÃO

Estrutura para revestimento de cobertura e fachada (madres)

Comprimento e furação de acordo com os requisitos

APPLICATION

Structure for roof and facade cladding (purlins and side rails)
Length and holes according to specifications

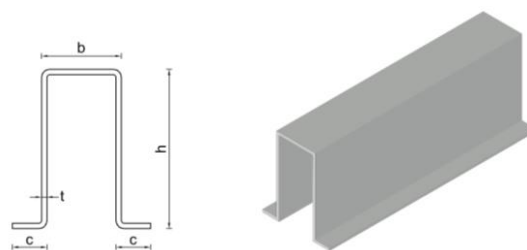

OMEGA R

APLICAÇÃO

Madres para cobertura e fachada de pavilhões industriais

Comprimento e furação de acordo com os requisitos

APPLICATION

Purlins and side rails for industrial buildings
Length and holes according to specifications

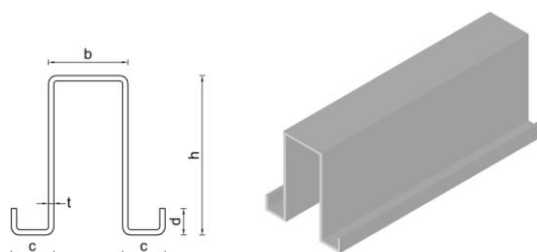

| Seção Section | h (mm) | b (mm) | c (mm) | t _{nom} (mm) | P (kg/m) |
|------------------|-----------|-----------|-----------|--------------------------|-------------|
| O40/40/15x1.5 | 40 | 40 | 15 | 1.5 | 1.66 |
| O50/40/16x1.5 | 50 | | 16 | 1.5 | 1.92 |
| O50/40/18x2.0 | | | 18 | 2.0 | 2.56 |
| O100/65/20x1.5 | 100 | 65 | 20 | 1.5 | 3.52 |
| O100/65/22x2.0 | | | 22 | 2.0 | 4.69 |
| O100/65/24x2.5 | | | 24 | 2.5 | 5.86 |
| O110/65/19x1.5 | 110 | 65 | 19 | 1.5 | 3.72 |
| O110/65/21x2.0 | | | 21 | 2.0 | 4.96 |
| O110/65/23x2.5 | | | 23 | 2.5 | 6.20 |
| O120/65/19x1.5 | 120 | 65 | 19 | 1.5 | 3.96 |
| O120/65/21x2.0 | | | 21 | 2.0 | 5.28 |
| O120/65/23x2.5 | | | 23 | 2.5 | 6.60 |
| O140/65/19x1.5 | 140 | 65 | 19 | 1.5 | 4.44 |
| O140/65/21x2.0 | | | 21 | 2.0 | 5.92 |
| O140/65/23x2.5 | | | 23 | 2.5 | 7.40 |
| O160/65/16x1.5 | 160 | 65 | 16 | 1.5 | 4.86 |
| O160/65/18x2.0 | | | 18 | 2.0 | 6.48 |
| O160/65/20x2.5 | | | 20 | 2.5 | 8.10 |

| Seção Section | h (mm) | b (mm) | c (mm) | d (mm) | t _{nom} (mm) | P (kg/m) |
|--------------------|-----------|-----------|-----------|-----------|--------------------------|-------------|
| OR100/60/16/7x1.5 | 98 | 60 | 16 | 7 | 1.5 | 3.32 |
| OR100/60/16/9x2.0 | | | | 9 | 2.0 | 4.43 |
| OR100/65/20/12x1.5 | 100 | 65 | 20 | 12 | 1.5 | 3.72 |
| OR100/65/20/15x2.0 | | | | 15 | 2.0 | 4.96 |
| OR100/65/20/18x2.5 | | | | 18 | 2.5 | 6.20 |
| OR120/65/20/9x1.5 | 120 | 65 | 20 | 9 | 1.5 | 4.14 |
| OR120/65/20/12x2.0 | | | | 12 | 2.0 | 5.52 |
| OR120/65/20/15x2.5 | | | | 15 | 2.5 | 6.90 |
| OR130/60/16/7x1.5 | 125 | 60 | 16 | 7 | 1.5 | 4.14 |
| OR130/60/16/9x2.0 | | | | 9 | 2.0 | 5.52 |
| OR130/65/20/10x2.0 | 135 | 65 | 20 | 10 | 2.0 | 5.92 |
| OR130/65/20/13x2.5 | | | | 13 | 2.5 | 7.40 |
| OR150/65/20/9x1.5 | | | | 150 | 65 | 20 |
| OR150/65/20/12x2.0 | 12 | 2.0 | 6.48 | | | |
| OR150/65/20/15x2.5 | 15 | 2.5 | 8.10 | | | |
| OR160/65/20/9x1.5 | 160 | 65 | 20 | 9 | 1.5 | 5.10 |
| OR160/65/20/12x2.0 | | | | 12 | 2.0 | 6.80 |
| OR160/65/20/15x2.5 | | | | 15 | 2.5 | 8.50 |

Outras dimensões sob consulta · Other dimensions on demand

Omega R b = 60 mm econômica · economic

SUPORTE · SUPPORT

APLICAÇÃO

Ligação para perfil OMEGA e OMEGA R

APPLICATION

Connection for section OMEGA and OMEGA R

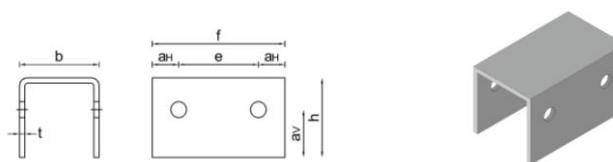

| Seção Section | h (mm) | b (mm) | ∅ (mm) | aH (mm) | e (mm) | f (mm) | aV (mm) | t _{nom} (mm) | P (kg/m) |
|------------------|-----------|-----------|-----------|------------|-----------|-----------|------------|--------------------------|-------------|
| SUP 2.0 | 70 | 60 | 14 | 28 | 70 | 125 | 40 | 2.0 | 3.07 |
| SUP 2.5 | | | | | | | | 2.5 | 3.84 |

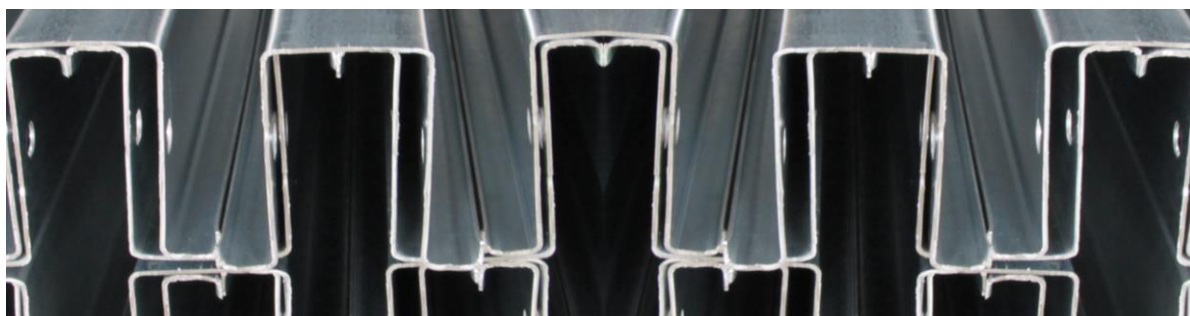

APLICAÇÃO

Estrutura para revestimento de cobertura e fachada (madres)

Comprimento e furação de acordo com os requisitos

APPLICATION

Structure for roof and facade cladding (purlins and side rails)
Length and holes according to specifications

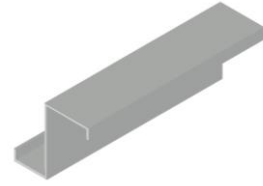
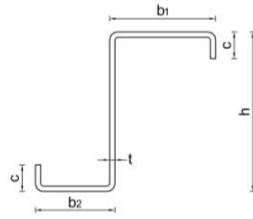

| Seção Section | h (mm) | b ₁ (mm) | b ₂ (mm) | c (mm) | t _{nom} (mm) | P (kg/m) | |
|-------------------|-----------|------------------------|------------------------|-----------|--------------------------|-------------|------|
| Z160/50-50/15x1.5 | 160 | 50 | 50 | 15 | 1.5 | 3.32 | |
| Z160/50-50/17x2.0 | | | | 17 | 2.0 | 4.43 | |
| Z160/60-60/21x1.5 | | 60 | 60 | 21 | 1.5 | 3.72 | |
| Z160/60-60/23x2.0 | | | | 23 | 2.0 | 4.96 | |
| Z160/60-60/25x2.5 | | | | 25 | 2.5 | 6.20 | |
| Z160/70-60/16x1.5 | | 70 | 60 | 16 | 1.5 | 3.72 | |
| Z160/70-60/18x2.0 | | | | 18 | 2.0 | 4.96 | |
| Z160/70-60/20x2.5 | | | | 20 | 2.5 | 6.20 | |
| Z160/70-70/11x1.5 | | | 70 | 70 | 11 | 1.5 | 3.72 |
| Z160/70-70/13x2.0 | | | | | 13 | 2.0 | 4.96 |
| Z160/70-70/15x2.5 | | | | | 15 | 2.5 | 6.20 |
| Z170/60-60/16x1.5 | | 170 | 60 | 16 | 1.5 | 3.72 | |
| Z170/60-60/18x2.0 | 18 | | | 2.0 | 4.96 | | |
| Z170/60-60/20x2.5 | 20 | | | 2.5 | 6.20 | | |
| Z180/60-60/21x1.5 | 180 | | 60 | 21 | 1.5 | 3.96 | |
| Z180/60-60/23x2.0 | | | | 23 | 2.0 | 5.28 | |
| Z180/60-60/25x2.5 | | | | 25 | 2.5 | 6.60 | |
| Z180/70-60/16x1.5 | | 70 | 60 | 16 | 1.5 | 3.96 | |
| Z180/70-60/18x2.0 | | | | 18 | 2.0 | 5.28 | |
| Z180/70-60/20x2.5 | | | | 20 | 2.5 | 6.60 | |
| Z180/70-70/19x1.5 | 70 | 70 | 19 | 1.5 | 4.14 | | |
| Z180/70-70/21x2.0 | | | 21 | 2.0 | 5.52 | | |
| Z180/70-70/23x2.5 | | | 23 | 2.5 | 6.90 | | |
| Z200/60-60/19x1.5 | | 200 | 60 | 19 | 1.5 | 4.14 | |
| Z200/60-60/21x2.0 | | | | 21 | 2.0 | 5.52 | |
| Z200/60-60/23x2.5 | | | | 23 | 2.5 | 6.90 | |
| Z200/70-60/14x1.5 | 70 | | 60 | 14 | 1.5 | 4.14 | |
| Z200/70-60/16x2.0 | | | | 16 | 2.0 | 5.52 | |
| Z200/70-60/18x2.5 | | | | 18 | 2.5 | 6.90 | |
| Z200/70-70/21x1.5 | | | 70 | 70 | 21 | 1.5 | 4.44 |
| Z200/70-70/23x2.0 | | | | | 23 | 2.0 | 5.92 |
| Z200/70-70/25x2.5 | | | | | 25 | 2.5 | 7.40 |
| Z200/80-70/16x1.5 | 80 | | 70 | 16 | 1.5 | 4.44 | |
| Z200/80-70/18x2.0 | | | | 18 | 2.0 | 5.92 | |
| Z200/80-70/20x2.5 | | | | 20 | 2.5 | 7.40 | |
| Z220/60-60/21x1.5 | | 220 | 60 | 21 | 1.5 | 4.44 | |
| Z220/60-60/23x2.0 | | | | 23 | 2.0 | 5.92 | |
| Z220/60-60/25x2.5 | | | | 25 | 2.5 | 7.40 | |
| Z220/70-60/16x1.5 | 70 | | 60 | 16 | 1.5 | 4.44 | |
| Z220/70-60/18x2.0 | | | | 18 | 2.0 | 5.92 | |
| Z220/70-60/20x2.5 | | | | 20 | 2.5 | 7.40 | |

Outras dimensões sob consulta · Other dimensions on demand

| Seção Section | h (mm) | b ₁ (mm) | b ₂ (mm) | c (mm) | t _{nom} (mm) | P (kg/m) | | | |
|-------------------|-----------|------------------------|------------------------|-----------|--------------------------|-------------|-------|-------|------|
| Z240/60-60/13x2.0 | 240 | 60 | 60 | 13 | 2.0 | 5.92 | | | |
| Z240/60-60/15x2.5 | | | | 15 | 2.5 | 7.40 | | | |
| Z240/70-60/24x1.5 | | 70 | 60 | 24 | 1.5 | 4.86 | | | |
| Z240/70-60/26x2.0 | | | | 26 | 2.0 | 6.48 | | | |
| Z240/70-60/28x2.5 | | | | 28 | 2.5 | 8.10 | | | |
| Z240/70-70/19x1.5 | | 70 | 70 | 19 | 1.5 | 4.86 | | | |
| Z240/70-70/21x2.0 | | | | 21 | 2.0 | 6.48 | | | |
| Z240/70-70/23x2.5 | | | | 23 | 2.5 | 8.10 | | | |
| Z240/80-70/14x1.5 | | | 80 | 70 | 14 | 1.5 | 4.86 | | |
| Z240/80-70/16x2.0 | | | | | 16 | 2.0 | 6.48 | | |
| Z240/80-70/18x2.5 | | | | | 18 | 2.5 | 8.10 | | |
| Z250/60-60/24x1.5 | | 250 | 60 | 24 | 1.5 | 4.86 | | | |
| Z250/60-60/26x2.0 | 26 | | | 2.0 | 6.48 | | | | |
| Z250/60-60/28x2.5 | 28 | | | 2.5 | 8.10 | | | | |
| Z250/70-60/19x1.5 | 70 | | 60 | 19 | 1.5 | 4.86 | | | |
| Z250/70-60/21x2.0 | | | | 21 | 2.0 | 6.48 | | | |
| Z250/70-60/23x2.5 | | | | 23 | 2.5 | 8.10 | | | |
| Z250/70-70/14x1.5 | | | 70 | 70 | 14 | 1.5 | 4.86 | | |
| Z250/70-70/16x2.0 | | | | | 16 | 2.0 | 6.48 | | |
| Z250/70-70/18x2.5 | | | | | 18 | 2.5 | 8.10 | | |
| Z250/80-70/19x1.5 | 80 | | 70 | 19 | 1.5 | 5.10 | | | |
| Z250/80-70/21x2.0 | | | | 21 | 2.0 | 6.80 | | | |
| Z250/80-70/23x2.5 | | | | 23 | 2.5 | 8.50 | | | |
| Z260/60-60/19x1.5 | | 260 | 60 | 19 | 1.5 | 4.86 | | | |
| Z260/60-60/21x2.0 | | | | 21 | 2.0 | 6.48 | | | |
| Z260/60-60/23x2.5 | | | | 23 | 2.5 | 8.10 | | | |
| Z260/70-60/14x1.5 | 70 | | 60 | 14 | 1.5 | 4.86 | | | |
| Z260/70-60/16x2.0 | | | | 16 | 2.0 | 6.48 | | | |
| Z260/70-60/18x2.5 | | | | 18 | 2.5 | 8.10 | | | |
| Z300/70-60/26x1.5 | | | 300 | 60 | 26 | 1.5 | 5.64 | | |
| Z300/70-60/28x2.0 | | | | | 28 | 2.0 | 7.52 | | |
| Z300/70-60/28x2.5 | | | | | 28 | 2.5 | 9.30 | | |
| Z300/70-60/32x3.0 | 70 | | | 60 | 32 | 3.0 | 11.28 | | |
| Z300/70-70/21x1.5 | | | | | 70 | 70 | 21 | 1.5 | 5.64 |
| Z300/70-70/23x2.0 | | | | | | | 23 | 2.0 | 7.52 |
| Z300/70-70/23x2.5 | 23 | 2.5 | | 9.30 | | | | | |
| Z300/70-70/27x3.0 | 70 | 70 | | 27 | | 3.0 | 11.28 | | |
| Z300/80-70/16x1.5 | | | | 80 | | 70 | 16 | 1.5 | 5.64 |
| Z300/80-70/18x2.0 | | | | | | | 18 | 2.0 | 7.52 |
| Z300/80-70/18x2.5 | 18 | 2.5 | | | 9.30 | | | | |
| Z300/80-70/22x3.0 | 80 | 70 | | | 22 | 3.0 | 11.28 | | |
| Z300/80-80/25x3.0 | | | 80 | | 70 | 25 | 3.0 | 11.64 | |
| Z375/96-85/30x4.0 | | | | | | 375 | 96 | 85 | 30 |



APLICAÇÃO

Estrutura para revestimento de cobertura e fachada (madres)

Comprimento e furação de acordo com os requisitos

APPLICATION

Structure for roof and facade cladding (purlins and side rails)

Length and holes according to specifications

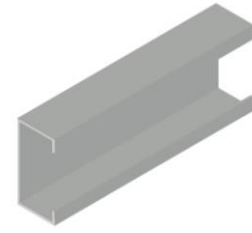
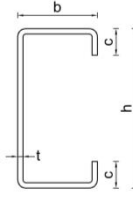

| Seção Section | h (mm) | b (mm) | c (mm) | t _{nom} (mm) | P (kg/m) | |
|------------------|-----------|-----------|-----------|--------------------------|-------------|------|
| C100/50/13x1.5 | 100 | 50 | 13 | 1.5 | 2.57 | |
| C100/50/15x2.0 | | | 15 | 2.0 | 3.42 | |
| C100/55/15x2.0 | | 55 | 15 | 2.0 | 3.58 | |
| C100/55/17x2.5 | | | 17 | 2.5 | 4.48 | |
| C120/55/16x1.5 | 120 | 55 | 16 | 1.5 | 3.00 | |
| C120/55/18x2.0 | | | 18 | 2.0 | 4.00 | |
| C120/55/20x2.5 | | 20 | 20 | 2.5 | 5.00 | |
| C120/60/11x1.5 | | | 60 | 11 | 1.5 | 3.00 |
| C120/60/13x2.0 | | 13 | | 2.0 | 4.00 | |
| C120/60/15x2.5 | | 15 | | 2.5 | 5.00 | |
| C140/50/11x1.5 | | 140 | | 50 | 11 | 1.5 |
| C140/50/13x2.0 | | | 13 | | 2.0 | 4.00 |
| C140/50/15x2.5 | 15 | | 2.5 | | 5.00 | |
| C140/55/20x1.5 | 55 | | 20 | 1.5 | 3.32 | |
| C140/55/22x2.0 | | | 22 | 2.0 | 4.43 | |
| C140/60/15x1.5 | 60 | | 15 | 1.5 | 3.32 | |
| C140/60/17x2.0 | | | 17 | 2.0 | 4.43 | |
| C140/65/18x1.5 | | | 65 | 18 | 1.5 | 3.52 |
| C140/65/20x2.0 | | | | 20 | 2.0 | 4.69 |
| C140/70/21x1.5 | 70 | | 21 | 1.5 | 3.72 | |
| C140/70/23x2.0 | | | 23 | 2.0 | 4.96 | |
| C140/70/25x2.5 | | | 25 | 2.5 | 6.20 | |
| C150/50/20x1.5 | | | 150 | 50 | 20 | 1.5 |
| C150/50/22x2.0 | 22 | | | | 2.0 | 4.43 |
| C150/55/15x1.5 | 55 | | | 15 | 1.5 | 3.32 |
| C150/55/17x2.0 | | | | 17 | 2.0 | 4.43 |
| C150/60/18x1.5 | 60 | 18 | | 1.5 | 3.52 | |
| C150/60/20x2.0 | | 20 | | 2.0 | 4.69 | |
| C150/65/13x1.5 | | 65 | | 13 | 1.5 | 3.52 |
| C150/65/15x2.0 | | | | 15 | 2.0 | 4.69 |
| C150/70/16x1.5 | 70 | 16 | | 1.5 | 3.72 | |
| C150/70/18x2.0 | | 18 | | 2.0 | 4.96 | |
| C150/70/20x2.5 | | 20 | | 2.5 | 6.20 | |
| C160/50/15x1.5 | | 160 | | 50 | 15 | 1.5 |
| C160/50/17x2.0 | 17 | | | | 2.0 | 4.43 |
| C160/55/18x1.5 | 55 | | | 18 | 1.5 | 3.52 |
| C160/55/20x2.0 | | | | 20 | 2.0 | 4.69 |
| C160/60/21x1.5 | 60 | | | 21 | 1.5 | 3.72 |
| C160/60/23x2.0 | | | 23 | 2.0 | 4.96 | |
| C160/60/25x2.5 | | | 25 | 2.5 | 6.20 | |
| C160/65/16x1.5 | | | 65 | 16 | 1.5 | 3.72 |
| C160/65/18x2.0 | 18 | | | 2.0 | 4.96 | |
| C160/65/20x2.5 | 70 | | 20 | 2.5 | 6.20 | |
| C160/70/11x1.5 | | | 70 | 11 | 1.5 | 3.72 |
| C160/70/21x1.5 | | | | 21 | 1.5 | 3.96 |
| C160/70/13x2.0 | | | | 13 | 2.0 | 4.96 |
| C160/70/23x2.0 | 23 | | | 2.0 | 5.28 | |
| C160/70/15x2.5 | 15 | | | 2.5 | 6.20 | |
| C160/70/25x2.5 | 25 | | | 2.5 | 6.60 | |
| C170/60/16x1.5 | 170 | 60 | | 16 | 1.5 | 3.72 |
| C170/60/18x2.0 | | | | 18 | 2.0 | 4.96 |
| C170/60/20x2.5 | | 20 | 2.5 | 6.20 | | |
| C180/60/21x1.5 | | 180 | 60 | 21 | 1.5 | 3.96 |
| C180/60/23x2.0 | 23 | | | 2.0 | 5.28 | |
| C180/60/25x2.5 | 25 | | 2.5 | 6.60 | | |
| C180/65/16x1.5 | 65 | | 16 | 1.5 | 3.96 | |
| C180/65/18x2.0 | | | 18 | 2.0 | 5.28 | |
| C180/65/20x2.5 | 70 | | 20 | 2.5 | 6.60 | |
| C180/70/19x1.5 | | | 19 | 1.5 | 4.14 | |
| C180/70/21x2.0 | | | 21 | 2.0 | 5.52 | |
| C180/70/23x2.5 | | 23 | 2.5 | 6.90 | | |
| C200/50/11x1.5 | 200 | 50 | 11 | 1.5 | 3.72 | |
| C200/50/13x2.0 | | | 13 | 2.0 | 4.96 | |
| C200/50/15x2.5 | | | 15 | 2.5 | 6.20 | |
| C200/55/16x1.5 | | | 55 | 16 | 1.5 | 3.96 |
| C200/55/18x2.0 | | 18 | | 2.0 | 5.28 | |
| C200/55/20x2.5 | | 20 | | 2.5 | 6.60 | |

Outras dimensões sob consulta · Other dimensions on demand

| Seção Section | h (mm) | b (mm) | c (mm) | t _{nom} (mm) | P (kg/m) | |
|------------------|-----------|-----------|-----------|--------------------------|-------------|-------|
| C200/60/19x1.5 | 200 | 60 | 19 | 1.5 | 4.14 | |
| C200/60/21x2.0 | | | 21 | 2.0 | 5.52 | |
| C200/60/23x2.5 | | | 23 | 2.5 | 6.90 | |
| C200/65/14x1.5 | | 65 | 14 | 1.5 | 4.14 | |
| C200/65/16x2.0 | | | 16 | 2.0 | 5.52 | |
| C200/65/18x2.5 | | | 18 | 2.5 | 6.90 | |
| C200/70/21x1.5 | | 70 | 21 | 1.5 | 4.44 | |
| C200/70/23x2.0 | | | 23 | 2.0 | 5.92 | |
| C200/70/25x2.5 | | | 25 | 2.5 | 7.40 | |
| C220/55/14x1.5 | | 220 | 55 | 14 | 1.5 | 4.14 |
| C220/55/16x2.0 | | | | 16 | 2.0 | 5.52 |
| C220/55/18x2.5 | | | | 18 | 2.5 | 6.90 |
| C220/60/21x1.5 | 60 | | 21 | 1.5 | 4.44 | |
| C220/60/23x2.0 | | | 23 | 2.0 | 5.92 | |
| C220/60/25x2.5 | | | 25 | 2.5 | 7.40 | |
| C220/65/16x1.5 | 65 | | 16 | 1.5 | 4.44 | |
| C220/65/18x2.0 | | | 18 | 2.0 | 5.92 | |
| C220/65/20x2.5 | | | 20 | 2.5 | 7.40 | |
| C220/70/11x1.5 | 70 | | 11 | 1.5 | 4.44 | |
| C220/70/13x2.0 | | | 13 | 2.0 | 5.92 | |
| C220/70/15x2.5 | | | 15 | 2.5 | 7.40 | |
| C225/80/16x1.5 | 225 | 80 | 16 | 1.5 | 4.86 | |
| C225/80/18x2.0 | | | 18 | 2.0 | 6.48 | |
| C225/80/20x2.5 | | | 20 | 2.5 | 8.10 | |
| C225/80/22x3.0 | | 22 | 3.0 | 9.72 | | |
| C225/80/26x4.0 | | 26 | 4.0 | 12.96 | | |
| C240/55/16x1.5 | | 240 | 55 | 16 | 1.5 | 4.44 |
| C240/55/18x2.0 | 18 | | | 2.0 | 5.92 | |
| C240/55/20x2.5 | 20 | | | 2.5 | 7.40 | |
| C240/60/13x2.0 | 60 | | 13 | 2.0 | 5.92 | |
| C240/60/15x2.5 | | | 15 | 2.5 | 7.40 | |
| C240/70/19x1.5 | | | 70 | 19 | 1.5 | 4.86 |
| C240/70/21x2.0 | 21 | | | 2.0 | 6.48 | |
| C240/70/23x2.5 | 23 | | | 2.5 | 8.10 | |
| C250/60/24x1.5 | 250 | | 60 | 24 | 1.5 | 4.86 |
| C250/60/26x2.0 | | | | 26 | 2.0 | 6.48 |
| C250/60/28x2.5 | | | | 28 | 2.5 | 8.10 |
| C250/65/19x1.5 | | | 65 | 19 | 1.5 | 4.86 |
| C250/65/21x2.0 | | 21 | | 2.0 | 6.48 | |
| C250/65/23x2.5 | | 23 | | 2.5 | 8.10 | |
| C250/70/14x1.5 | | 70 | 14 | 1.5 | 4.86 | |
| C250/70/16x2.0 | | | 16 | 2.0 | 6.48 | |
| C250/70/18x2.5 | | | 18 | 2.5 | 8.10 | |
| C260/60/19x1.5 | | 260 | 60 | 19 | 1.5 | 4.86 |
| C260/60/21x2.0 | | | | 21 | 2.0 | 6.48 |
| C260/60/23x2.5 | | | | 23 | 2.5 | 8.10 |
| C260/65/14x1.5 | 65 | | 14 | 1.5 | 4.86 | |
| C260/65/16x2.0 | | | 16 | 2.0 | 6.48 | |
| C260/65/18x2.5 | | | 18 | 2.5 | 8.10 | |
| C260/70/19x1.5 | 70 | | 19 | 1.5 | 5.10 | |
| C260/70/21x2.0 | | | 21 | 2.0 | 6.80 | |
| C260/70/23x2.5 | | | 23 | 2.5 | 8.50 | |
| C275/80/25x2.5 | 275 | | 80 | 25 | 2.5 | 9.30 |
| C275/80/25x3.0 | | | | 25 | 3.0 | 11.04 |
| C280/60/19x1.5 | | | | 60 | 19 | 1.5 |
| C280/60/21x2.0 | | 21 | 2.0 | | 6.80 | |
| C280/60/23x2.5 | | 23 | 2.5 | | 8.50 | |
| C280/65/14x1.5 | | 65 | 14 | 1.5 | 5.10 | |
| C280/65/16x2.0 | 16 | | 2.0 | 6.80 | | |
| C280/65/18x2.5 | 18 | | 2.5 | 8.50 | | |
| C300/70/21x1.5 | 300 | 70 | 21 | 1.5 | 5.64 | |
| C300/70/23x2.0 | | | 23 | 2.0 | 7.52 | |
| C300/70/23x2.5 | | | 23 | 2.5 | 9.30 | |
| C300/70/27x3.0 | | 80 | 27 | 3.0 | 11.28 | |
| C300/80/25x3.0 | | | 25 | 3.0 | 11.64 | |
| C325/65/14x1.5 | | | 325 | 65 | 14 | 1.5 |
| C325/65/16x2.0 | 16 | 2.0 | | | 7.52 | |
| C325/65/15x2.5 | 15 | 2.5 | | 9.30 | | |
| C325/65/20x3.0 | 20 | 3.0 | | 11.28 | | |

APLICAÇÃO

Perfil de separação entre o revestimento de cobertura existente e novo

FIG A – a reentrância no banzo inferior permite acomodar os parafusos do revestimento existente

FIG B – banzo superior para fixar o revestimento novo e furação no banzo inferior para fixar o perfil G40 à estrutura existente

APPLICATION

Separation section between existing and new roof cladding

FIG A – the recess in the lower flange allows to accommodate the bolts from the existing cladding

FIG B – upper flange to fix the new cladding and holes in the lower flange to fix section G40 to the existing structure

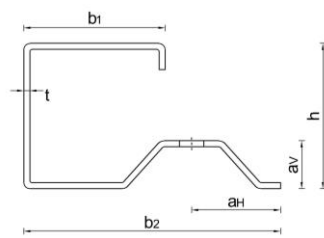
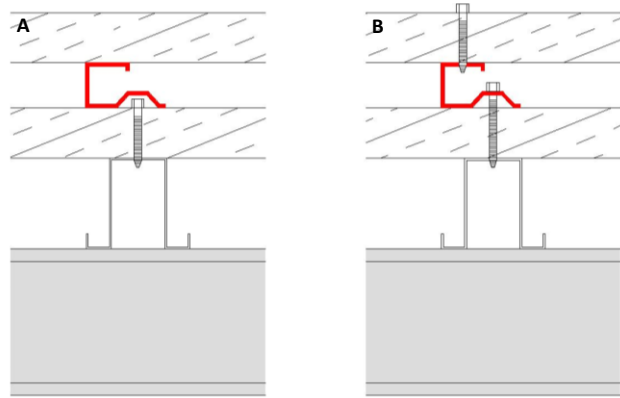

| Seção Section | h (mm) | b ₁ (mm) | b ₂ (mm) | t _{nom} (mm) | Ø (mm) | a _v (mm) | a _H (mm) | P (kg/m) |
|------------------|-----------|------------------------|------------------------|--------------------------|----------------|------------------------|------------------------|-------------|
| G40 | 38 | 35 | 64 | 1.5 | 9.0x15.0 // 50 | 15 | 22 | 1.66 |



TUBULAR

APLICAÇÃO

Viga e pilar para a execução de pisos, escadas e coberturas

O perfil TUBULAR é composto por 2 secções ligadas por parafusos M8

APPLICATION

Beam and column for the execution of floors, mezzanine, stairs and roofs

Section TUBULAR is the result of 2 sections connected by M8 bolts

| Seção Section | h (mm) | b (mm) | t _{nom} (mm) | P (kg/m) |
|------------------|-----------|-----------|--------------------------|-------------|
| Tubular 170 | 170 | 100 | 2.5 | 12.40 |
| Tubular 230 | 230 | | | 14.80 |
| Tubular 265 | 265 | | | 16.20 |

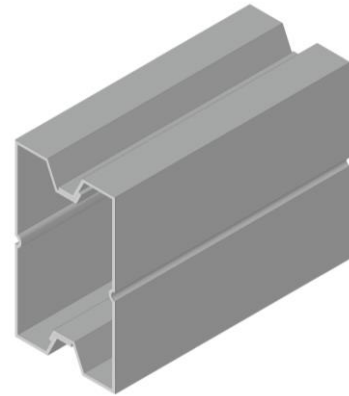
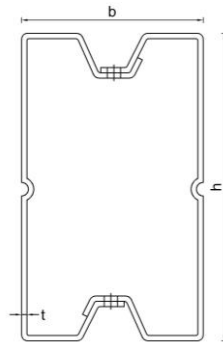



HABITAÇÃO
RESIDENCE

APLICAÇÃO

Pisos, coberturas e platibandas

- (1) cordas definidas por perfil RBF ou CP
- (2) diagonais definidas por perfil UB40 ou UB60
- (3) a calha no banzo superior do perfil RBF permite a ligação a outros perfis através de parafuso rômbo

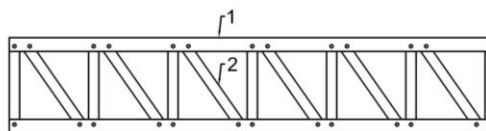

APPLICATION

Floors, roof and parapets

- (1) chords in section RBF or section CP
- (2) diagonals in section UB40 or UB60
- (3) the upper flange of RBF has a channel that allows the connection to other sections through rhombic bolts

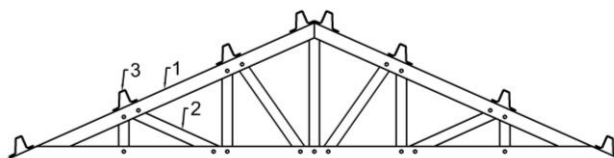

COBERTURA VÃO APROVEITADO · ATTIC ROOF

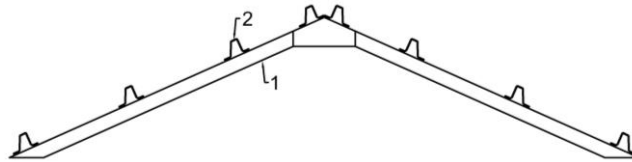

APLICAÇÃO

Estrutura de cobertura com vão aproveitado

(1) viga definida pelas seguintes alternativas: TUBULAR, VIGA TRELIÇADA, RBF, RBF & OB35/40 ou RBF & UB120

(2) ripa definida pelas seguintes alternativas: OB40/20 ou OB60/20 para telha cerâmica, OB100, ÔMEGA ou ÔMEGA R para painel de cobertura

APPLICATION

Structure for attic roof

(1) beam defined by the following alternatives: TUBULAR, TRUSS BEAM, RBF, RBF & OB35/40 or RBF & UB120

(2) purlin defined by the following alternatives: OB40/20 or OB60/20 for ceramic roof tiles, OB100, OMEGA or OMEGA R for roof panel



RBF

APLICAÇÃO

Viga treliçada, estrutura de cobertura, estrutura de suporte de painéis fotovoltaicos

Calha no banzo superior do perfil RBF permite a ligação a outros perfis através de parafuso rômbo

APPLICATION

Truss beam, roof structure, support structure for photovoltaic panels

The channel on the upper flange of section RBF allows the connection to other sections through rhombic bolts

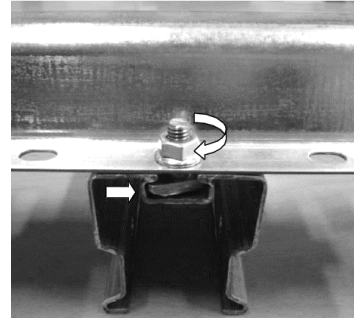
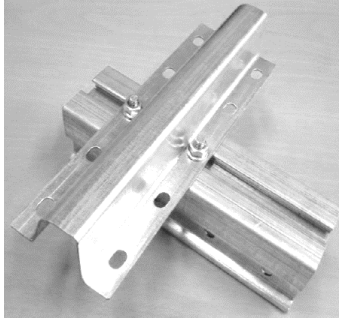
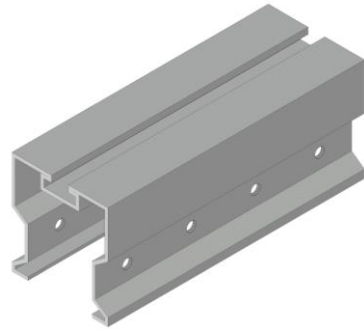
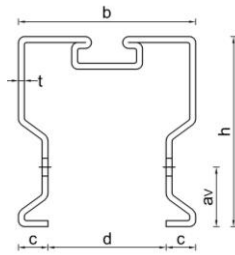

Estrutura de cobertura com fixação das ripas em qualquer posição simplificando a montagem em obra
Roof structure with purlin connection in any position simplifying the construction on site

RBF & OB35/40

APLICAÇÃO

Estrutura de cobertura com aproveitamento do vão

Perfil composto pelas secções RBF e OB35/40 ligadas por parafusos M8

APPLICATION

Attic roof

Section composed by sections RBF and OB35/40 connected by M8 bolts

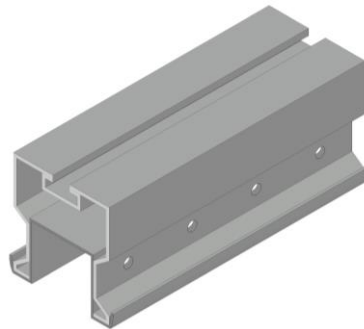
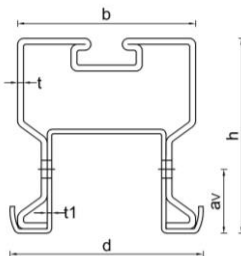

RBF & UB120

APLICAÇÃO

Estrutura de cobertura com aproveitamento do vão

Perfil composto pelas secções RBF e UB120 ligadas por parafusos M8

APPLICATION

Attic roof

Section composed by sections RBF and UB120 connected by M8 bolts

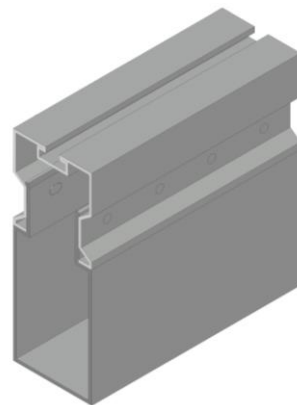
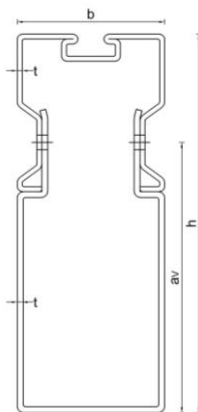

| Seção Section | h (mm) | b (mm) | c (mm) | d (mm) | t _{nom} (mm) | ∅ (mm) | av (mm) | P (kg/m) |
|------------------|-----------|-----------|-----------|-----------|--------------------------|----------------|------------|-------------|
| RBF | 64 | 60 | 10 | 40 | 2.0 | 9.0 // 50 | 20 | 3.58 |
| RBF & OB35/40 | 66 | 60 | -- | 65 | 2.0 / 1.5 | 9.0x13.0 // 50 | 22 | 5.24 |
| RBF & UB120 | 154 | 60 | -- | -- | 2.0 | 9.0 // 50 | 110 | 8.54 |

CP

APLICAÇÃO

Viga treliçada, estrutura de cobertura

APPLICATION

Truss beam, roof structure

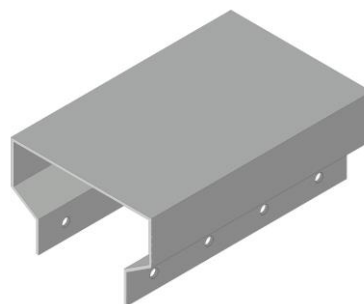
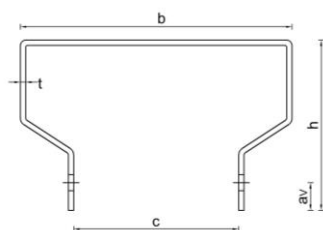

UB40 · UB60

APLICAÇÃO

Diagonal de viga treliçada
 Perfil UB40 com perfil RBF
 Perfil UB60 com perfil CP

APPLICATION

Diagonal of truss beam
 Section UB40 with section RBF
 Section UB60 with section CP

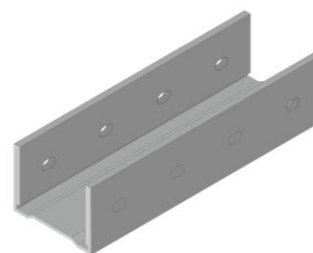
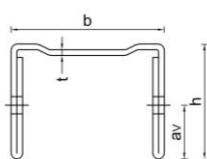

| Seção Section | h (mm) | b (mm) | c (mm) | t _{nom} (mm) | ∅ (mm) | av (mm) | P (kg/m) |
|------------------|-----------|-----------|-----------|--------------------------|----------------|------------|-------------|
| CP | 60 | 96 | 58 | 2.0 | 9.0 // 50 | 20 | 3.58 |
| UB40 | 30 | 40 | -- | 1.5 | 9.0x13.0 // 50 | 20 | 1.66 |
| UB60 | 30 | 58 | -- | 1.5 | 9.0x13.0 // 50 | 20 | 1.92 |



RIPAS · PURLINS

APLICAÇÃO

Perfis para suporte de telha cerâmica

- OB20/20, OB20/10 e OB30/10 como sub-ripa
- OB30/10 com furos nas almas para ventilação
- OB40/20 e OB60/20 como ripa

APPLICATION

Sections for the support of roof tile

- OB20/20, OB20/10 and OB30/10 as sub-purlin
- OB30/10 with holes in the web for ventilation
- OB40/20 and OB60/20 as purlin

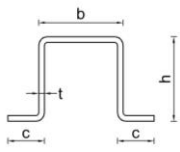
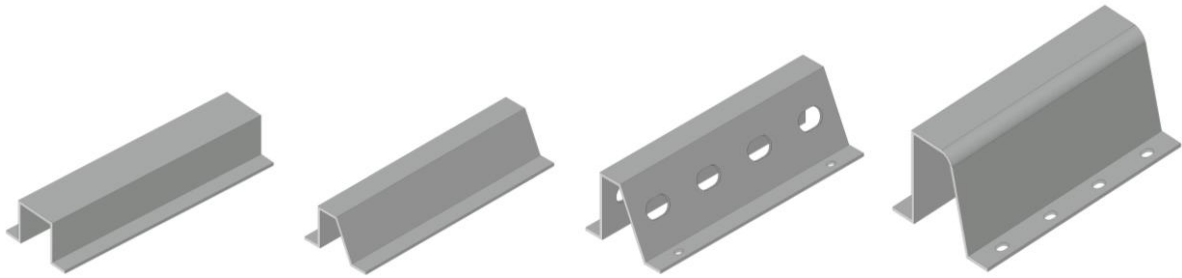

OB20/20

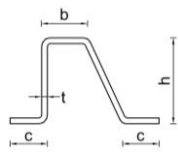

OB20/10

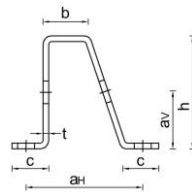

OB30/10

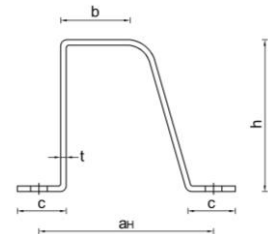

OB40/20 · OB60/20

| Seção Section | h (mm) | b (mm) | c (mm) | t _{nom} (mm) | ∅ (mm) | a _H (mm) | a _V (mm) | P (kg/m) |
|------------------|-----------|-----------|-----------|--------------------------|---|------------------------|------------------------|-------------|
| OB20/20x0.6 | 20 | 20 | 16 | 0.6 | -- | -- | -- | 0.42 |
| OB20/20x0.8 | | | | 0.8 | | | | 0.56 |
| OB20/10x0.6 | | 10 | 15 | 0.6 | | | | 0.39 |
| OB20/10x0.8 | | | | 0.8 | | | | 0.52 |
| OB30/10x0.8 | 30 | 10 | 16 | 0.8 | H: 6.0x10.0 // 300 V: 14.0x20.0 // 100 | 46 | 15 | 0.67 |
| OB40/20x1.5 | 40 | 20 | 20 | 1.5 | 13.0x9.0 // 50 | 60 | -- | 1.66 |
| OB60/20x1.2 | 55 | | | 1.2 | | | | 1.70 |



APLICAÇÃO

Estrutura de paredes, pisos e cobertura composta por perfis C (montantes) & U (canais)
 Comprimento e furação de acordo com os requisitos



APPLICATION

Walls, floors and roofs structure composed by sections C (vertical) & U (channel)
 Length and holes according to specifications

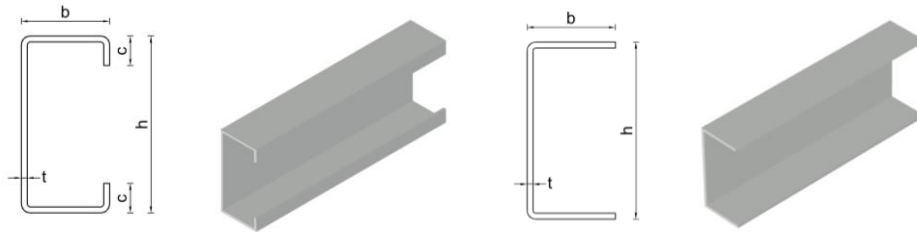

| Seção Section | h (mm) | b (mm) | c (mm) | t _{nom} (mm) | P (kg/m) |
|------------------|-----------|-----------|-----------|--------------------------|-------------|
| C90/43/15x1.5 | 90 | 43 | 15 | 1.5 | 2.23 |
| C150/43/15x1.5 | 150 | | | 1.5 | 3.00 |
| C200/43/15x2.0 | 200 | | | 2.0 | 4.80 |
| C250/43/15x2.5 | 250 | | | 2.5 | 6.90 |
| U93/40x1.5 | 93 | 40 | - | 1.5 | 2.00 |
| U153/40x1.5 | 153 | | | 1.5 | 2.72 |
| U204/41x2.0 | 204 | 41 | | 2.0 | 4.43 |
| U255/43x2.5 | 255 | 43 | | 2.5 | 6.60 |

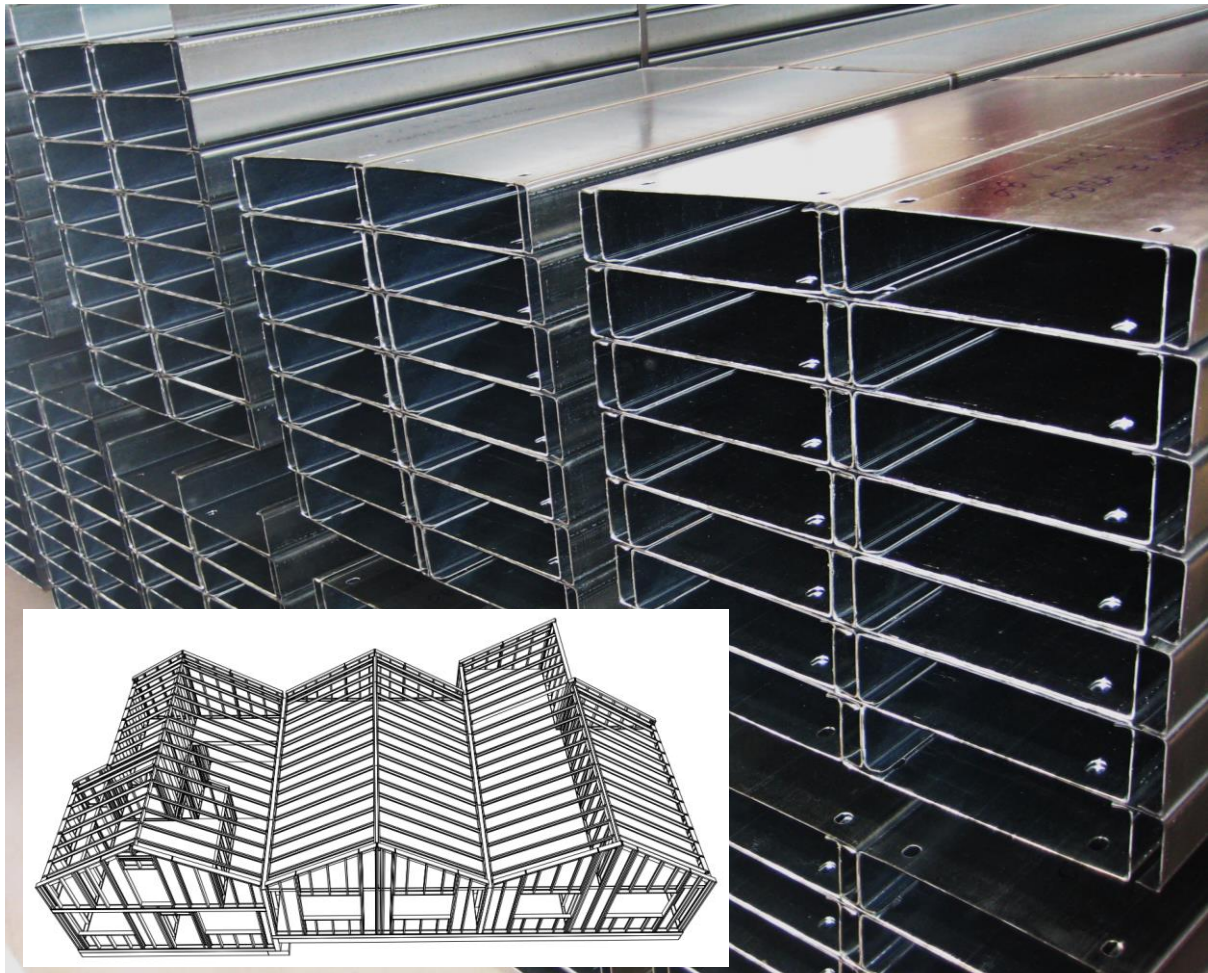



ENERGIA
ENERGY

PERFIS PARA PAINÉIS FOTOVOLTAICOS SECTIONS FOR PHOTOVOLTAIC PANELS

APLICAÇÃO

Estrutura de suporte para painéis fotovoltaicos definida pelos perfis: (1) RBF, (2) UB40, (3) UF40/40 e USF35/45 e (4) CF

- UF40/40 – banzo superior preparado para porca M10 com mola para fixar perfil intermédio de ligação aos painéis fotovoltaicos
- USF35/45 – perfil de ligação para garantir continuidade entre UF40/40
- CF – perfil para passagem de cabos

APPLICATION

Support structure for photovoltaic panels defined by sections: (1) RBF, (2) UB40, (3) UF40/40 and USF34/45 and (4) CF

- UF40/40 – upper flange prepared for M10 nut with Spring to fix intermediate section of connection to photovoltaic panels
- USF35/45 – connection section between UF40/40 to guarantee continuity
- CF – section for cable running

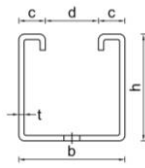
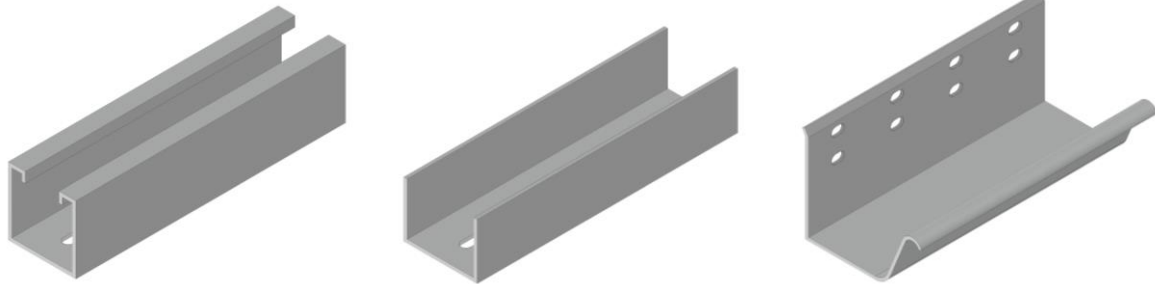
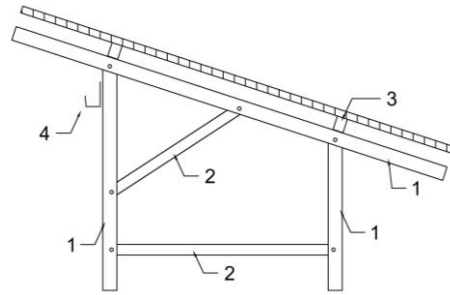

UF40/40

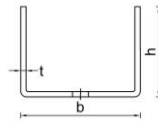

USF34/45

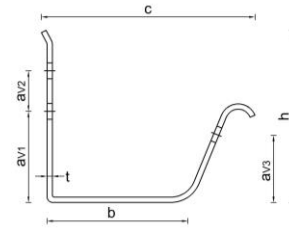

CF

| Seção Section | h (mm) | b (mm) | c (mm) | t _{nom} (mm) | ∅ (mm) | a _{v1} (mm) | a _{v2} (mm) | a _{v3} (mm) | P (kg/m) |
|------------------|-----------|-----------|-----------|--------------------------|----------------|-------------------------|-------------------------|-------------------------|-------------|
| UF40/40 | 40 | 40 | 10 | 2.0 | 9.0x24.0 // 50 | -- | -- | -- | 2.08 |
| USF34/45 | 34 | 45 | -- | 2.0 | 9.0x24.0 // 50 | -- | -- | -- | 1.68 |
| CF | 70 | 52 | 86 | 1.2 | 9.0x13.0 // 50 | 35 | 20 | 30 | 1.70 |



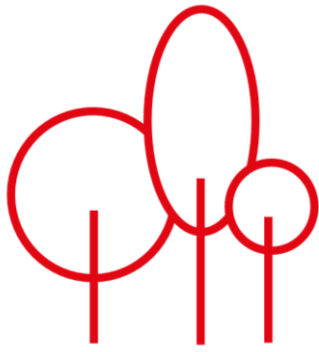

AGRICULTURA
AGRICULTURE

PERFIS PARA ESTUFAS · SECTIONS FOR GREENHOUSES

APLICAÇÃO

Perfis para clipar plástico: HE40/38, CE18/28, UE40/25
 Caleiro para escoamento de água

APPLICATION

Sections to clip plastic: HE40/38, CE18/28, UE40/25
 Gutter for water drainage

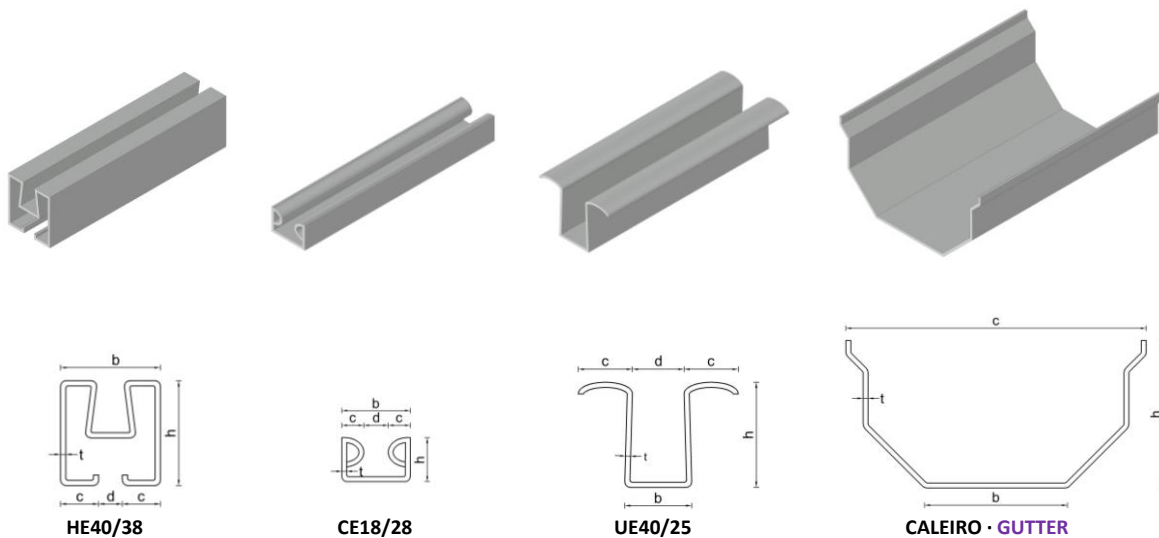

| Seção Section | h (mm) | b (mm) | c (mm) | d (mm) | t _{nom} (mm) | P (kg/m) |
|------------------|-----------|-----------|-----------|-----------|--------------------------|-------------|
| HE40/38 | 147 | 142 | 295 | -- | 2.0 | 7.92 |
| CE18/28 | 40 | 38 | 14 | 10 | 1.2 | 1.70 |
| UE40/25 | 18 | 28 | 9 | 10 | 1.2 | 0.84 |
| CALEIRO · GUTTER | 40 | 25 | 20 | 21 | 1.5 | 1.56 |



ESTACA · STAKE

APLICAÇÃO

Estaca para diferentes culturas agrícolas
Furos tipo Z nas almas com 100 mm de afastamento, 50 mm da extremidade, para fixação de arame

APPLICATION

Stake for different agriculture cultures
Z type holes in the webs with 100 mm spacing, 50 mm from the edge, for wire support

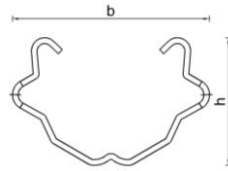

ESTACA A STAKE A

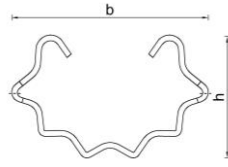
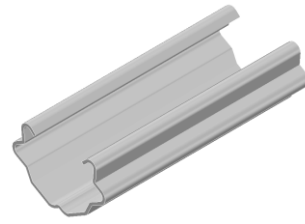

ESTACA B STAKE B

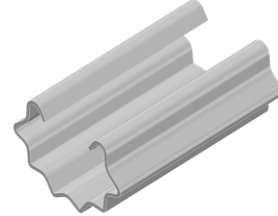

CABECEIRA · HEADSTAKE

APLICAÇÃO

Estaca de cabeceira para diferentes culturas agrícolas

Furos redondo 8 mm na alma com 100 mm de afastamento para fixação de arame

APPLICATION

Headstake for different agriculture cultures
Circular hole with 8 mm in the web with 100 mm spacing for wire support

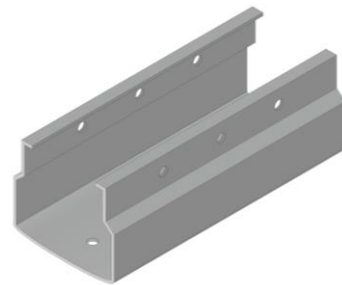
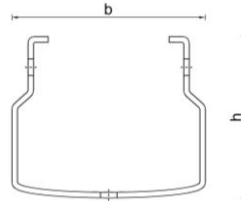

| Seção Section | h (mm) | b (mm) | t _{nom} (mm) | P (kg/m) | Esquema de Furação Hole Scheme | L (m) | f (mm) | g (m) | n (un) | ∅ (mm) | a (mm) | |
|------------------------|-----------|-----------|--------------------------|-------------|-----------------------------------|-----------------|-----------|----------|-----------|-----------|-----------|-----|
| ESTACA STAKE | 34 | 52 | 1.2 | 1.04 | | Lateral Side | 1.50 | 50 | 0.70 | 8 | Z16.0 | 100 |
| | | | 1.5 | 1.30 | | | 2.00 | | | | | |
| | | | 1.8 | 1.56 | | | 2.20 | | | | | |
| | | | | | | | | | | | | |
| CABECEIRA HEADSTAKE | 50 | 42 | 2.0 | 2.08 | | Base Bottom | 2.20 | 50 | 1.32 | 12 | 8.0 | 120 |
| | | | | | | | 2.40 | | | | | 120 |
| | | | | | | Lateral Side | 2.60 | 100 | 1.32 | 12 | | 120 |
| | | | | | | | | | | | | |



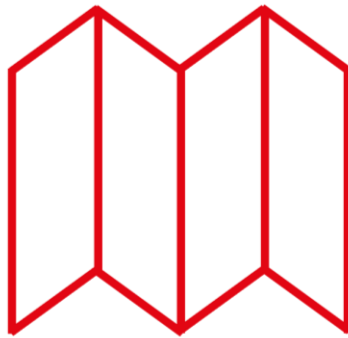

PORTÕES
GATES

PERFIL PORTÃO DE CORRER · SECTION FOR SLIDING GATE

APLICAÇÃO

Perfil guia para portão de correr

APPLICATION

Rail section for sliding gate

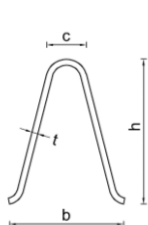

GUIA DE CHUMBAR · CEMENT FIXING RAIL

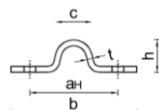
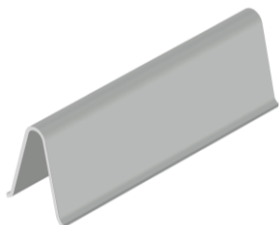

GUIA DE APARAFUSAR · SURFACE FIXING RAIL

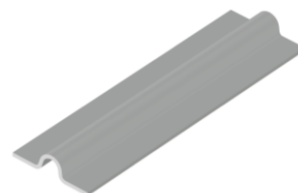

| Seção Section | Roda Wheel | h (mm) | b (mm) | c (mm) | t _{nom} (mm) | a _H (mm) | φ (mm) | P (kg/m) |
|---|---------------|-----------|-----------|-----------|--------------------------|------------------------|------------|-------------|
| GUIA DE CHUMBAR CEMENT FIXING RAIL | Ø16 mm | 60 | 48 | 16 | 2.5 | -- | -- | 2.48 |
| | Ø20mm | 56 | 48 | 20 | 2.5 | -- | -- | 2.48 |
| GUIA DE APARAFUSAR SURFACE FIXING RAIL | Ø16 mm | 14 | 54 | 16 | 2.5 | 38 | 9.0 // 500 | 1.24 |

PORTÕES DE FOLE · FOLDING GATES

APLICAÇÃO

Portão de segurança para edifícios industriais ou residenciais
Portão em chapa de aço galvanizada ou plastificada com guias superior e inferior e fechadura de linguete com gancho

APPLICATION

Security gate for industrial or residential buildings
Galvanized or plastic-coated steel sheet gate with upper and lower rails and bolt lock hook



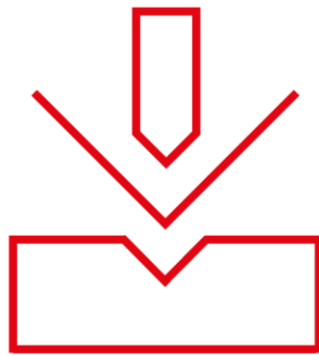

CORTE E QUINAGEM
CUTTING AND PRESS BRAKING

APLICAÇÃO

Perfis personalizados em chapa de aço até 12 m de comprimento
Comprimento e furação de acordo com os requisitos

APPLICATION

Custom-made steel sections until 12 m of length
Length and holes according to specifications

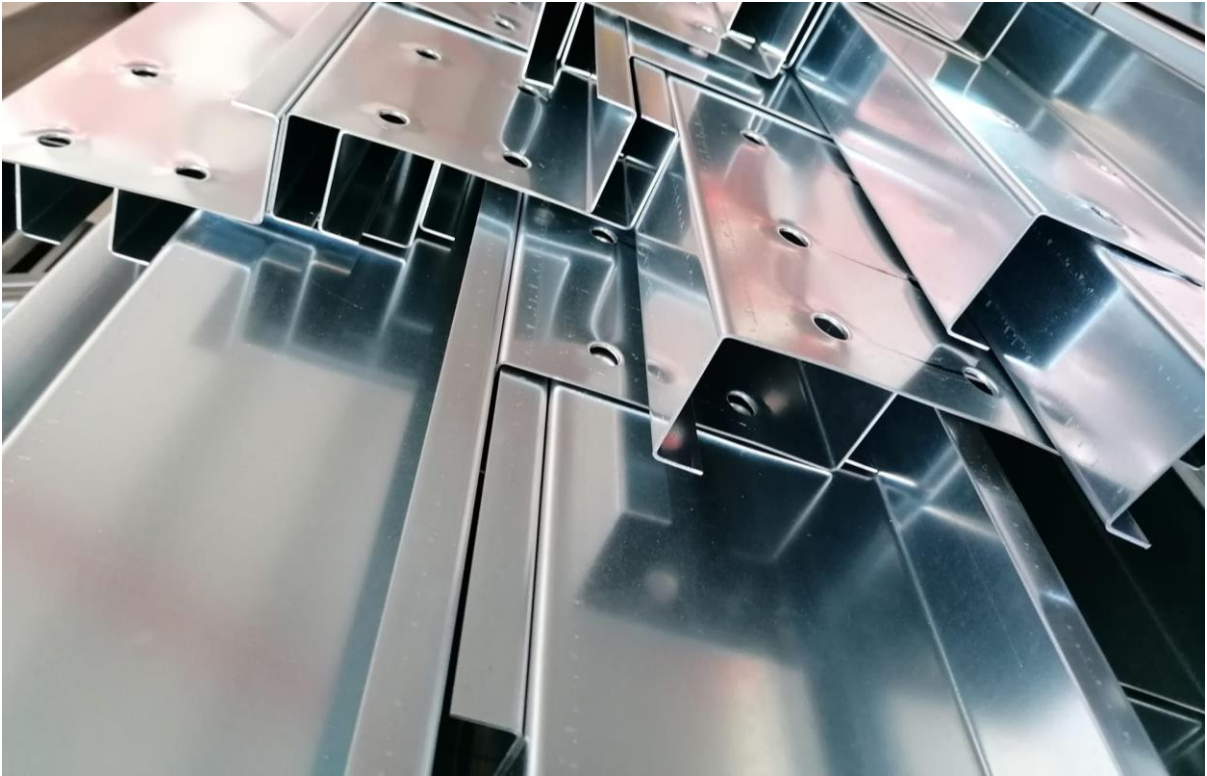



PROPRIEDADES DOS MATERIAIS
MATERIAL PROPERTIES

AÇO GALVANIZADO · GALVANIZED STEEL

EN 10346

Aço ao carbono de qualidade estrutural com revestimento de zinco por imersão contínua a quente
Continuous hot dip zinc coated carbon steel sheet of structural quality

| Classe de Aço Steel Grade | Tensão de cedência Basic yield strength | Tensão de rotura Tensile strength | Revestimento Coating | Espessura · Thickness (µm) | |
|------------------------------|--|--------------------------------------|--------------------------------|-------------------------------|--------------------|
| | f_{yb} (MPa) | f_u (MPa) | | Valor típico Typical Value | Intervalo Range |
| S220GD+Z | 220 | 300 | Z200 | 14 | 10 – 20 |
| S280GD+Z | 280 | 360 | Z275 | 20 | 13 – 27 |
| S320GD+Z | 320 | 390 | ZM310 | 24 | 18 – 31 |
| S350GD+Z | 350 | 420 | Z – Zinco, ZM – Zinco-Magnésio | | |

AÇO INOXIDÁVEL · STAINLESS STEEL

EN 10088

Aço inoxidável austenítico
Austenitic stainless steel

| Classe de Aço Steel Grade | Tensão de cedência Basic yield strength | Tensão de rotura Tensile strength |
|------------------------------|--|--------------------------------------|
| | f_{yb} (MPa) | f_u (MPa) |
| 304 2B (1.4301) | 230 | 540 |
| 316 2B (1.4401) | 240 | 530 |

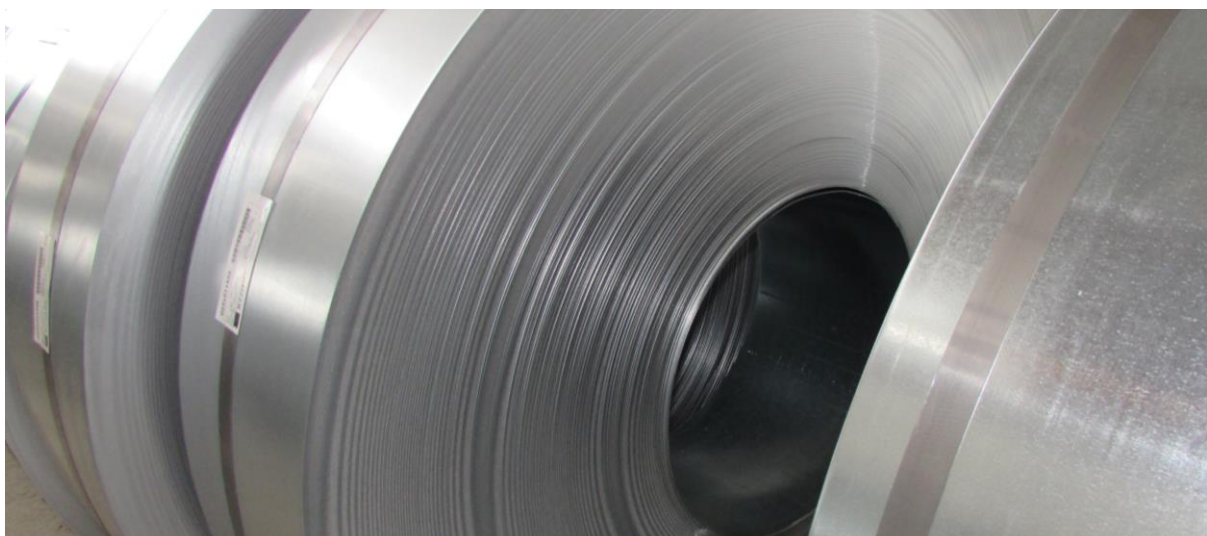
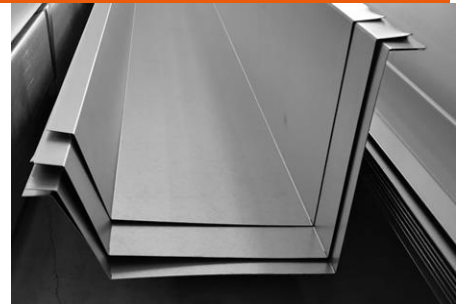



Rua Bartolomeu Dias, 8
Parque Industrial Manuel da Mota
3100-354 Pombal
Portugal

(+351) 236 212 418
custo de chamada para a rede fixa nacional
geral@barraferros.com



WWW.BARRAFERROS.COM

